

# MC33201 MC33202 MC33204



**ON Semiconductor**  
Formerly a Division of Motorola  
<http://onsemi.com>

## Rail-to-Rail Operational Amplifiers

The MC33201/2/4 family of operational amplifiers provide rail-to-rail operation on both the input and output. The inputs can be driven as high as 200 mV beyond the supply rails without phase reversal on the outputs, and the output can swing within 50 mV of each rail. This rail-to-rail operation enables the user to make full use of the supply voltage range available. It is designed to work at very low supply voltages ( $\pm 0.9$  V) yet can operate with a supply of up to +12 V and ground. Output current boosting techniques provide a high output current capability while keeping the drain current of the amplifier to a minimum. Also, the combination of low noise and distortion with a high slew rate and drive capability make this an ideal amplifier for audio applications.

- Low Voltage, Single Supply Operation (+1.8 V and Ground to +12 V and Ground)
- Input Voltage Range Includes both Supply Rails
- Output Voltage Swings within 50 mV of both Rails
- No Phase Reversal on the Output for Over-driven Input Signals
- High Output Current ( $I_{SC} = 80$  mA, Typ)
- Low Supply Current ( $I_D = 0.9$  mA, Typ)
- 600  $\Omega$  Output Drive Capability
- Extended Operating Temperature Ranges ( $-40^\circ$  to  $+105^\circ\text{C}$  and  $-55^\circ$  to  $+125^\circ\text{C}$ )
- Typical Gain Bandwidth Product = 2.2 MHz

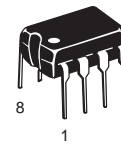

**P SUFFIX  
CASE 626**

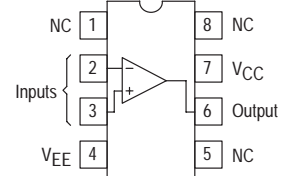

(Single, Top View)



**(SO-8)  
D SUFFIX  
CASE 751**



**(Micro-8)  
DM SUFFIX  
CASE 846A**

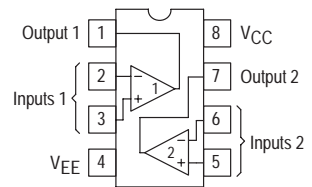

(Dual, Top View)

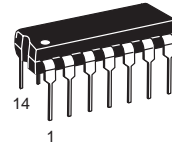

**P SUFFIX  
CASE 646**

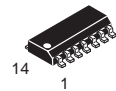

**(SO-14)  
D SUFFIX  
CASE 751A**



**(TSSOP-14)  
DTB SUFFIX  
CASE 948G**

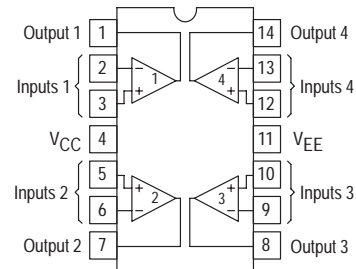

(Quad, Top View)

### ORDERING INFORMATION

See detailed ordering and shipping information in the package dimensions section on page 10 of this data sheet.

# MC33201 MC33202 MC33204

**Figure 1. Circuit Schematic**  
(Each Amplifier)

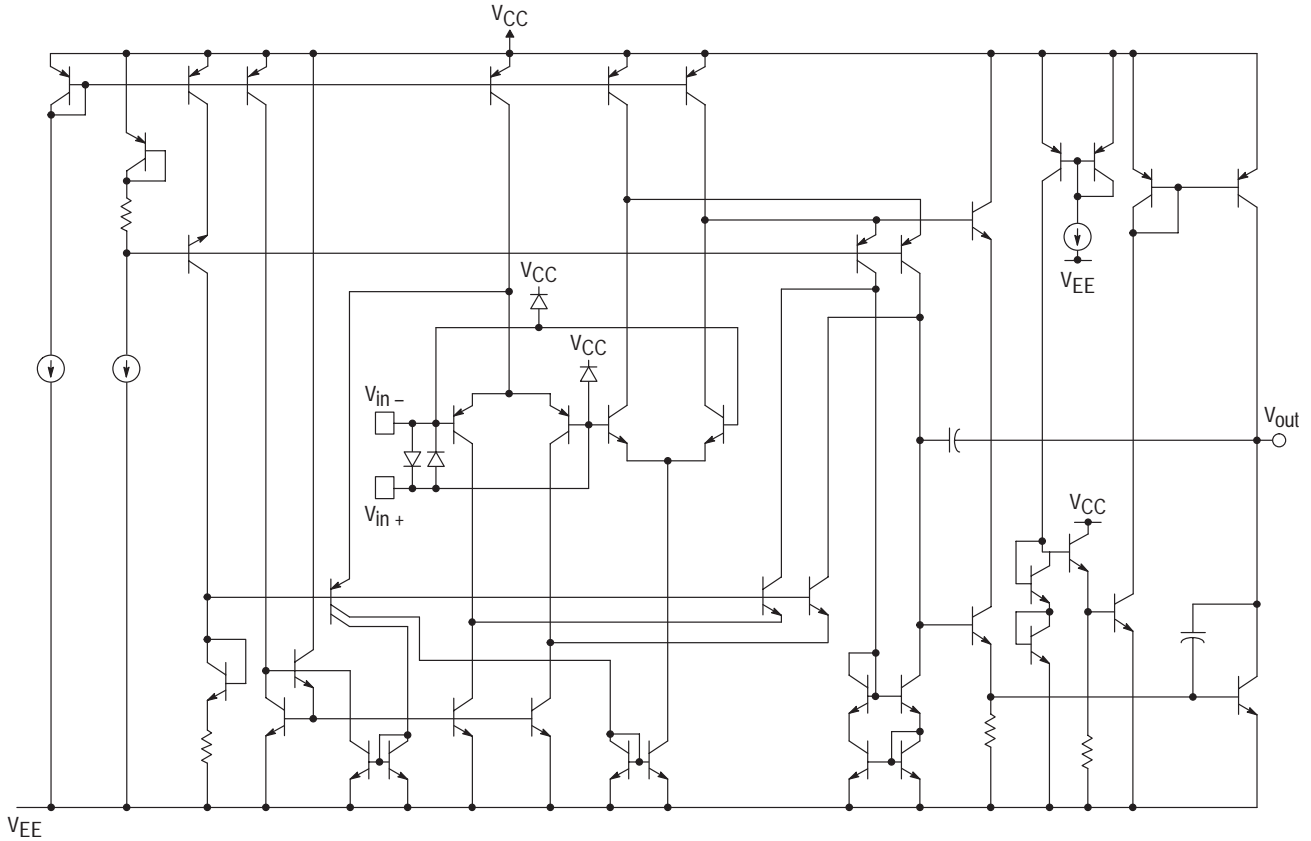

This device contains 70 active transistors (each amplifier).

## MAXIMUM RATINGS

Rating	Symbol	Value	Unit
Supply Voltage ( $V_{CC}$ to $V_{EE}$ )	$V_S$	+13	V
Input Differential Voltage Range	$V_{IDR}$	(Note 1)	V
Common Mode Input Voltage Range (Note 2)	$V_{CM}$	$V_{CC} + 0.5\text{ V}$ to $V_{EE} - 0.5\text{ V}$	V
Output Short Circuit Duration	$t_s$	(Note 3)	sec
Maximum Junction Temperature	$T_J$	+150	°C
Storage Temperature	$T_{stg}$	- 65 to +150	°C
Maximum Power Dissipation	$P_D$	(Note 3)	mW

- NOTES:** 1. The differential input voltage of each amplifier is limited by two internal parallel back-to-back diodes. For additional differential input voltage range, use current limiting resistors in series with the input pins.  
 2. The input common mode voltage range is limited by internal diodes connected from the inputs to both supply rails. Therefore, the voltage on either input must not exceed either supply rail by more than 500 mV.  
 3. Power dissipation must be considered to ensure maximum junction temperature ( $T_J$ ) is not exceeded. (See Figure 2)

# MC33201 MC33202 MC33204

## DC ELECTRICAL CHARACTERISTICS ( $T_A = 25^\circ\text{C}$ )

Characteristic	$V_{CC} = 2.0\text{ V}$	$V_{CC} = 3.3\text{ V}$	$V_{CC} = 5.0\text{ V}$	Unit
Input Offset Voltage $V_{IO}$ (max) MC33201 MC33202 MC33204	$\pm 8.0$ $\pm 10$ $\pm 12$	$\pm 8.0$ $\pm 10$ $\pm 12$	$\pm 6.0$ $\pm 8.0$ $\pm 10$	mV
Output Voltage Swing $V_{OH}$ ( $R_L = 10\text{ k}\Omega$ ) $V_{OL}$ ( $R_L = 10\text{ k}\Omega$ )	1.9 0.10	3.15 0.15	4.85 0.15	$V_{min}$ $V_{max}$
Power Supply Current per Amplifier ( $I_D$ )	1.125	1.125	1.125	mA

Specifications at  $V_{CC} = 3.3\text{ V}$  are guaranteed by the 2.0 V and 5.0 V tests.  $V_{EE} = \text{Gnd}$ .

## DC ELECTRICAL CHARACTERISTICS ( $V_{CC} = +5.0\text{ V}$ , $V_{EE} = \text{Ground}$ , $T_A = 25^\circ\text{C}$ , unless otherwise noted.)

Characteristic	Figure	Symbol	Min	Typ	Max	Unit
Input Offset Voltage ( $V_{CM} = 0\text{ V to } 0.5\text{ V}$ , $V_{CM} = 1.0\text{ V to } 5.0\text{ V}$ ) MC33201: $T_A = +25^\circ\text{C}$ $T_A = -40^\circ\text{ to } +105^\circ\text{C}$ $T_A = -55^\circ\text{ to } +125^\circ\text{C}$ MC33202: $T_A = +25^\circ\text{C}$ $T_A = -40^\circ\text{ to } +105^\circ\text{C}$ $T_A = -55^\circ\text{ to } +125^\circ\text{C}$ MC33204: $T_A = +25^\circ\text{C}$ $T_A = -40^\circ\text{ to } +105^\circ\text{C}$ $T_A = -55^\circ\text{ to } +125^\circ\text{C}$	3	$ V_{IO} $	– – –	– – –	6.0 9.0 13 8.0 11 14 10 13 17	mV
Input Offset Voltage Temperature Coefficient ( $R_S = 50\ \Omega$ ) $T_A = -40^\circ\text{ to } +105^\circ\text{C}$ $T_A = -55^\circ\text{ to } +125^\circ\text{C}$	4	$\Delta V_{IO}/\Delta T$	– –	2.0 2.0	– –	$\mu\text{V}/^\circ\text{C}$
Input Bias Current ( $V_{CM} = 0\text{ V to } 0.5\text{ V}$ , $V_{CM} = 1.0\text{ V to } 5.0\text{ V}$ ) $T_A = +25^\circ\text{C}$ $T_A = -40^\circ\text{ to } +105^\circ\text{C}$ $T_A = -55^\circ\text{ to } +125^\circ\text{C}$	5, 6	$ I_{IB} $	– – –	80 100 –	200 250 500	nA
Input Offset Current ( $V_{CM} = 0\text{ V to } 0.5\text{ V}$ , $V_{CM} = 1.0\text{ V to } 5.0\text{ V}$ ) $T_A = +25^\circ\text{C}$ $T_A = -40^\circ\text{ to } +105^\circ\text{C}$ $T_A = -55^\circ\text{ to } +125^\circ\text{C}$	–	$ I_{IO} $	– – –	5.0 10 –	50 100 200	nA
Common Mode Input Voltage Range	–	$V_{ICR}$	$V_{EE}$	–	$V_{CC}$	V
Large Signal Voltage Gain ( $V_{CC} = +5.0\text{ V}$ , $V_{EE} = -5.0\text{ V}$ ) $R_L = 10\text{ k}\Omega$ $R_L = 600\ \Omega$	7	$A_{VOL}$	50 25	300 250	– –	kV/V
Output Voltage Swing ( $V_{ID} = \pm 0.2\text{ V}$ ) $R_L = 10\text{ k}\Omega$ $R_L = 10\text{ k}\Omega$ $R_L = 600\ \Omega$ $R_L = 600\ \Omega$	8, 9, 10	$V_{OH}$ $V_{OL}$ $V_{OH}$ $V_{OL}$	4.85 – 4.75 –	4.95 0.05 4.85 0.15	– 0.15 – 0.25	V
Common Mode Rejection ( $V_{in} = 0\text{ V to } 5.0\text{ V}$ )	11	CMR	60	90	–	dB
Power Supply Rejection Ratio $V_{CC}/V_{EE} = 5.0\text{ V/Gnd to } 3.0\text{ V/Gnd}$	12	PSRR	500	25	–	$\mu\text{V/V}$
Output Short Circuit Current (Source and Sink)	13, 14	$I_{SC}$	50	80	–	mA
Power Supply Current per Amplifier ( $V_O = 0\text{ V}$ ) $T_A = -40^\circ\text{ to } +105^\circ\text{C}$ $T_A = -55^\circ\text{ to } +125^\circ\text{C}$	15	$I_D$	– –	0.9 0.9	1.125 1.125	mA

# MC33201 MC33202 MC33204

## AC ELECTRICAL CHARACTERISTICS ( $V_{CC} = +5.0\text{ V}$ , $V_{EE} = \text{Ground}$ , $T_A = 25^\circ\text{C}$ , unless otherwise noted.)

Characteristic	Figure	Symbol	Min	Typ	Max	Unit
Slew Rate ( $V_S = \pm 2.5\text{ V}$ , $V_O = -2.0\text{ V}$ to $+2.0\text{ V}$ , $R_L = 2.0\text{ k}\Omega$ , $A_V = +1.0$ )	16, 26	SR	0.5	1.0	–	V/ $\mu\text{s}$
Gain Bandwidth Product ( $f = 100\text{ kHz}$ )	17	GBW	–	2.2	–	MHz
Gain Margin ( $R_L = 600\ \Omega$ , $C_L = 0\text{ pF}$ )	20, 21, 22	$A_M$	–	12	–	dB
Phase Margin ( $R_L = 600\ \Omega$ , $C_L = 0\text{ pF}$ )	20, 21, 22	$\theta_M$	–	65	–	Deg
Channel Separation ( $f = 1.0\text{ Hz}$ to $20\text{ kHz}$ , $A_V = 100$ )	23	CS	–	90	–	dB
Power Bandwidth ( $V_O = 4.0\text{ V}_{pp}$ , $R_L = 600\ \Omega$ , $\text{THD} \leq 1\%$ )		BWP	–	28	–	kHz
Total Harmonic Distortion ( $R_L = 600\ \Omega$ , $V_O = 1.0\text{ V}_{pp}$ , $A_V = 1.0$ ) f = 1.0 kHz f = 10 kHz	24	THD	– –	0.002 0.008	– –	%
Open Loop Output Impedance ( $V_O = 0\text{ V}$ , $f = 2.0\text{ MHz}$ , $A_V = 10$ )		$ Z_O $	–	100	–	$\Omega$
Differential Input Resistance ( $V_{CM} = 0\text{ V}$ )		$R_{in}$	–	200	–	k $\Omega$
Differential Input Capacitance ( $V_{CM} = 0\text{ V}$ )		$C_{in}$	–	8.0	–	pF
Equivalent Input Noise Voltage ( $R_S = 100\ \Omega$ ) f = 10 Hz f = 1.0 kHz	25	$e_n$	– –	25 20	– –	nV/ $\sqrt{\text{Hz}}$
Equivalent Input Noise Current f = 10 Hz f = 1.0 kHz	25	$i_n$	– –	0.8 0.2	– –	pA/ $\sqrt{\text{Hz}}$

Figure 2. Maximum Power Dissipation versus Temperature

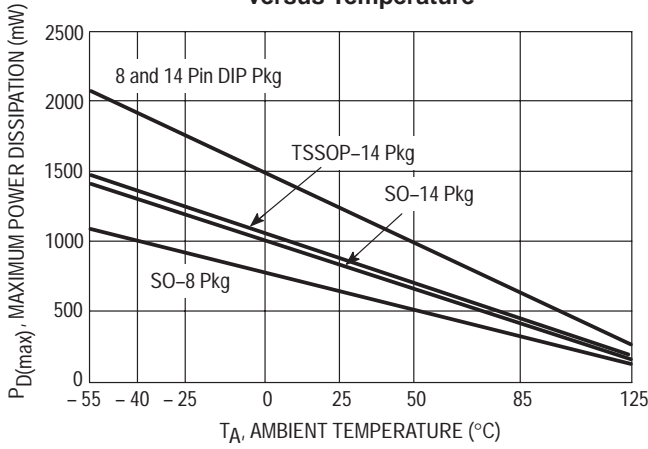

Figure 3. Input Offset Voltage Distribution

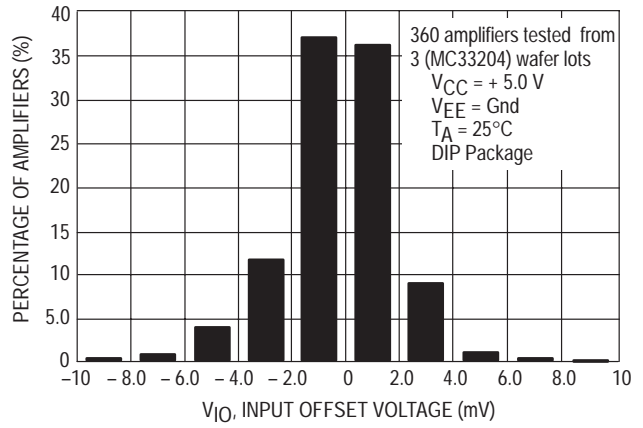

Figure 4. Input Offset Voltage Temperature Coefficient Distribution

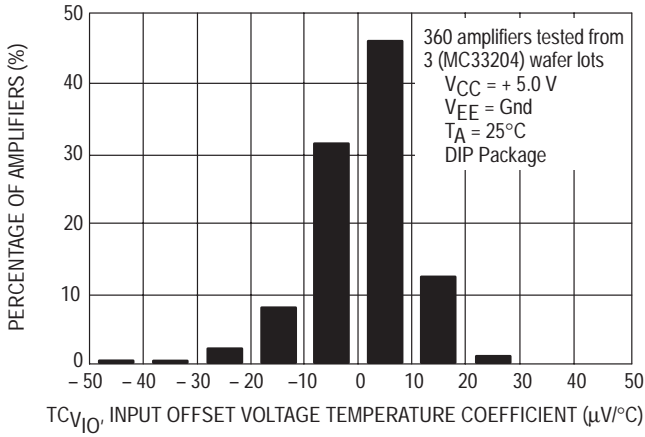

Figure 5. Input Bias Current versus Temperature

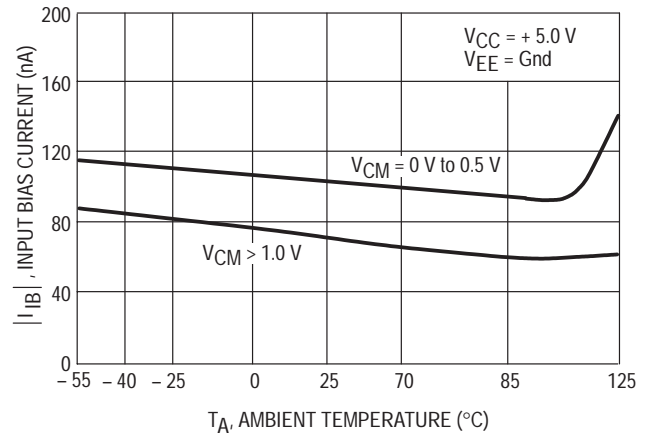

Figure 6. Input Bias Current versus Common Mode Voltage

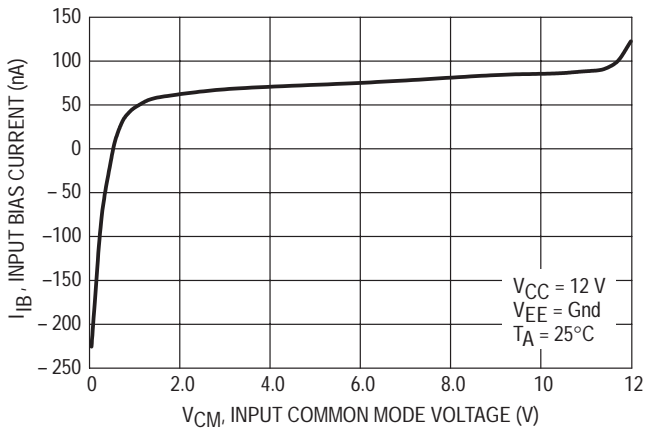

Figure 7. Open Loop Voltage Gain versus Temperature

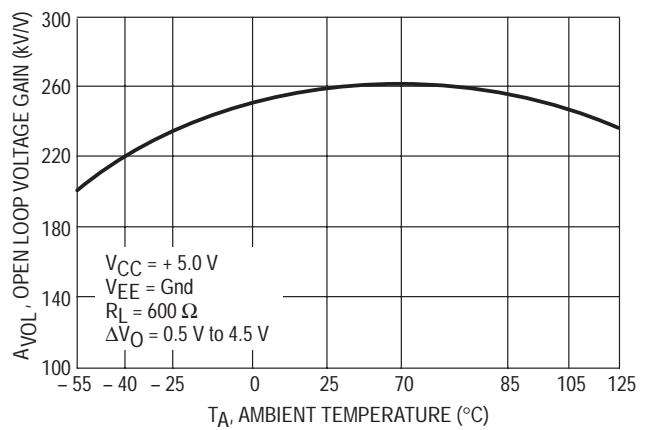

Figure 8. Output Voltage Swing versus Supply Voltage

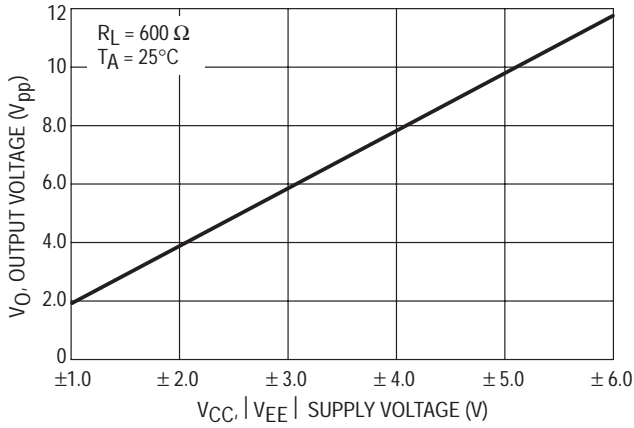

Figure 9. Output Saturation Voltage versus Load Current

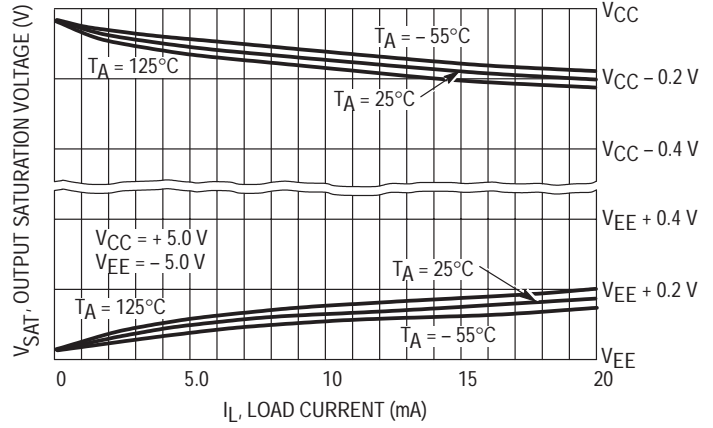

Figure 10. Output Voltage versus Frequency

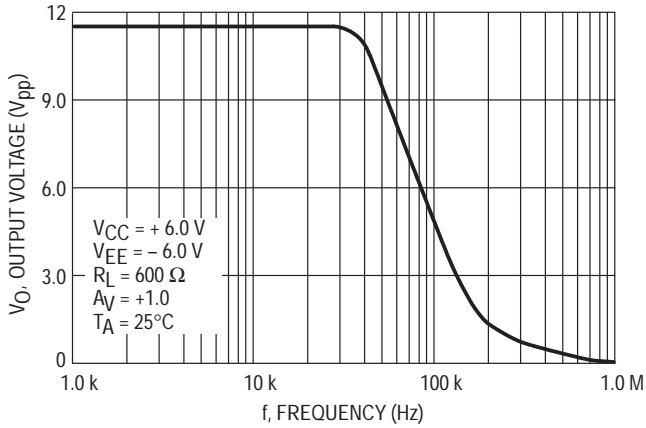

Figure 11. Common Mode Rejection versus Frequency

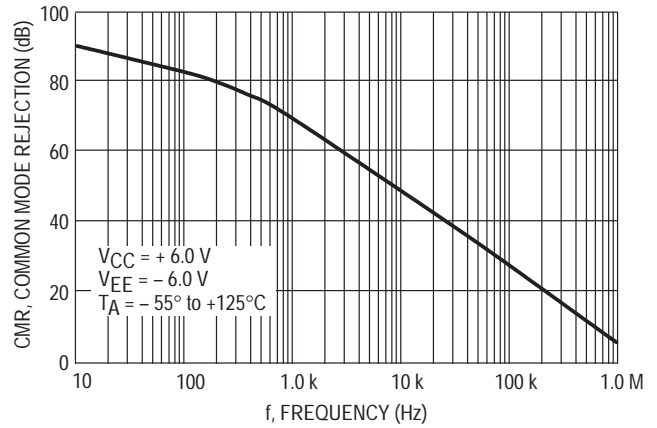

Figure 12. Power Supply Rejection versus Frequency

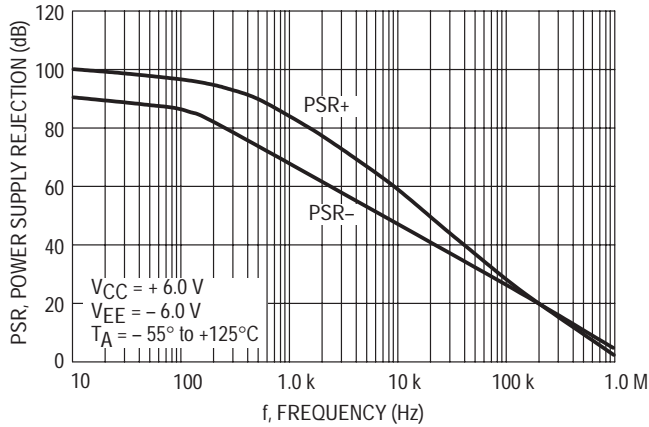

Figure 13. Output Short Circuit Current versus Output Voltage

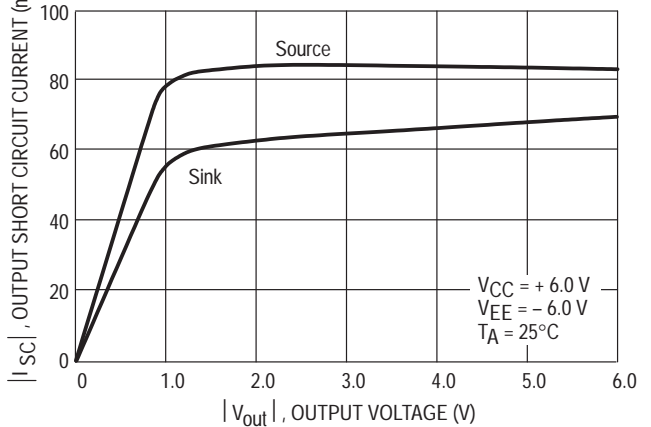

Figure 14. Output Short Circuit Current versus Temperature

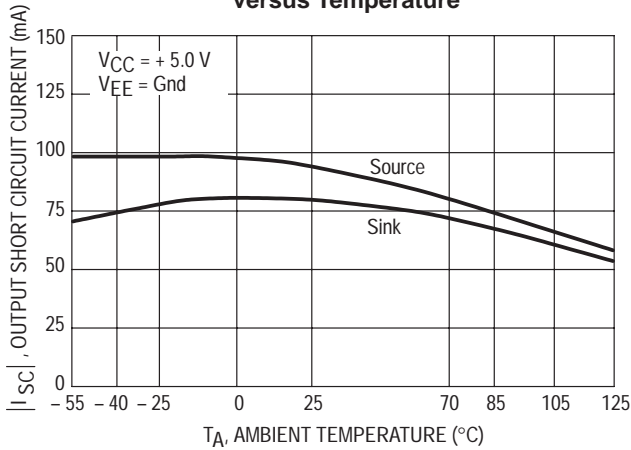

Figure 15. Supply Current per Amplifier versus Supply Voltage with No Load

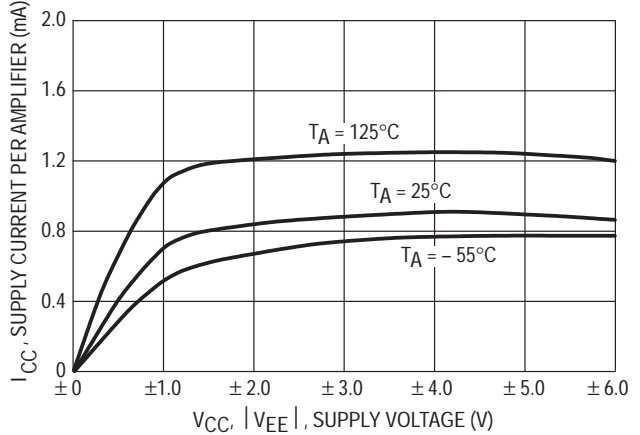

Figure 16. Slew Rate versus Temperature

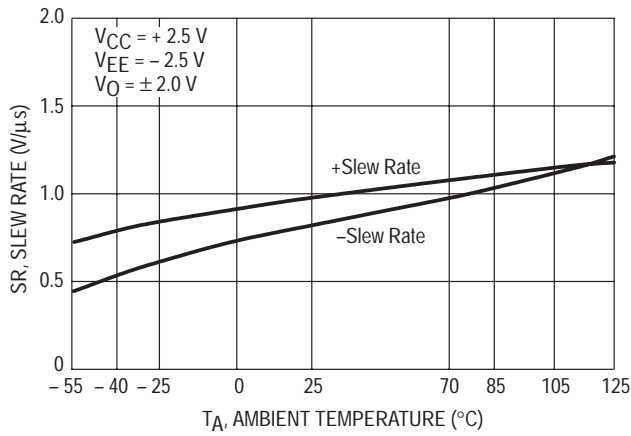

Figure 17. Gain Bandwidth Product versus Temperature

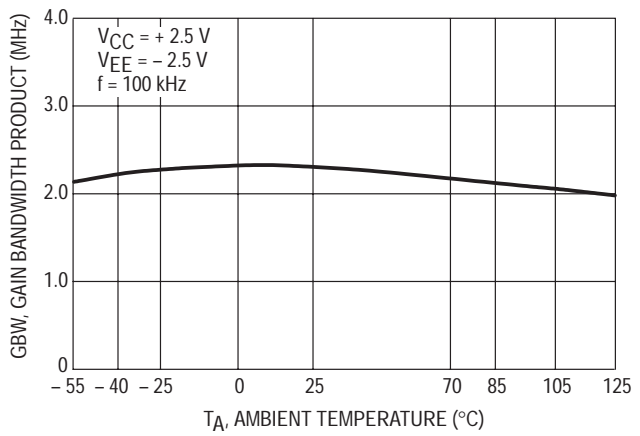

Figure 18. Voltage Gain and Phase versus Frequency

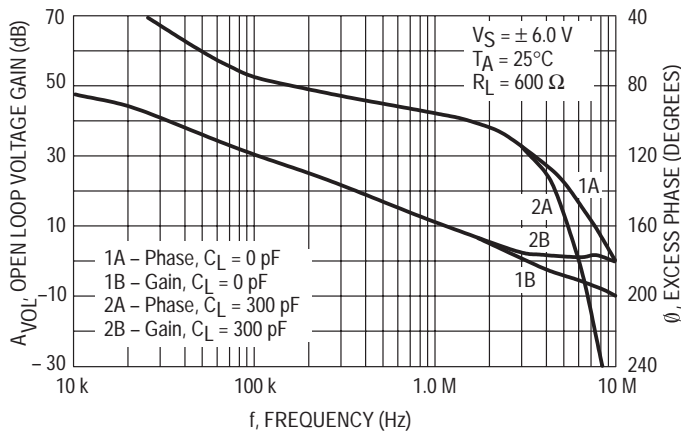

Figure 19. Voltage Gain and Phase versus Frequency

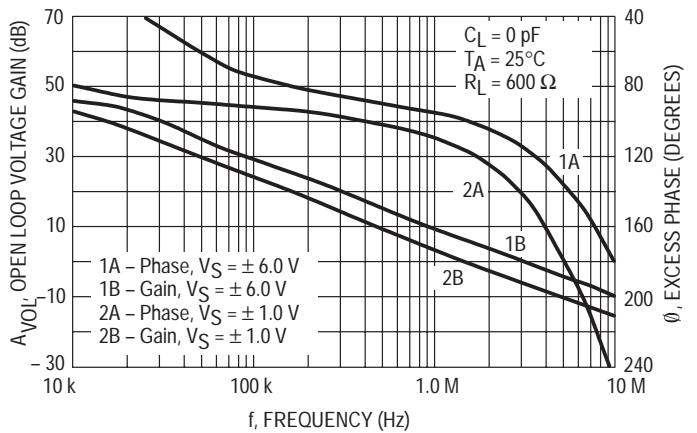

Figure 20. Gain and Phase Margin versus Temperature

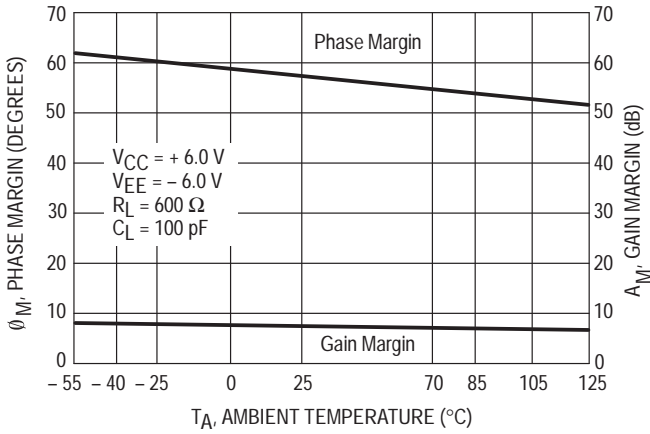

Figure 21. Gain and Phase Margin versus Differential Source Resistance

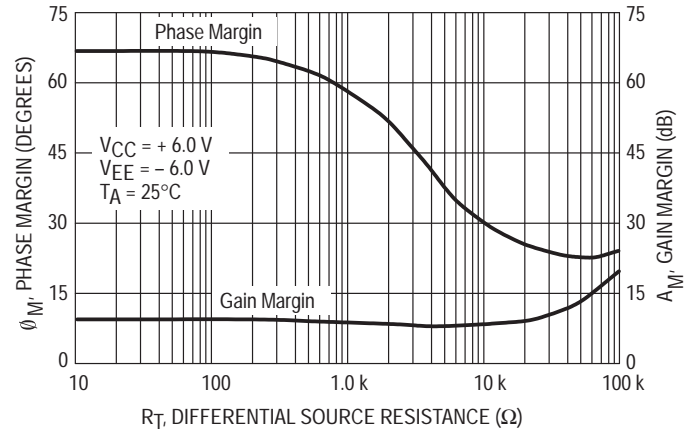

Figure 22. Gain and Phase Margin versus Capacitive Load

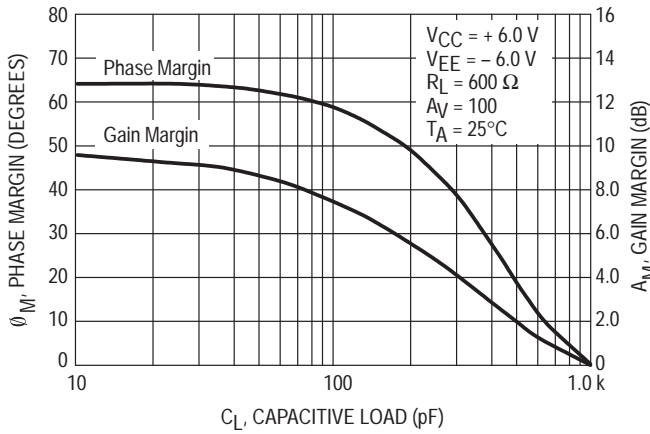

Figure 23. Channel Separation versus Frequency

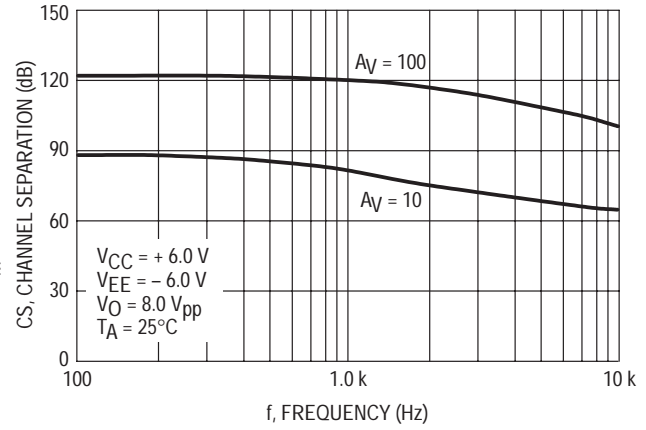

Figure 24. Total Harmonic Distortion versus Frequency

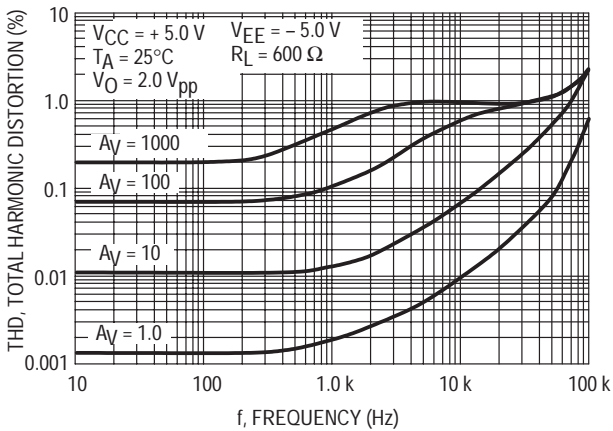
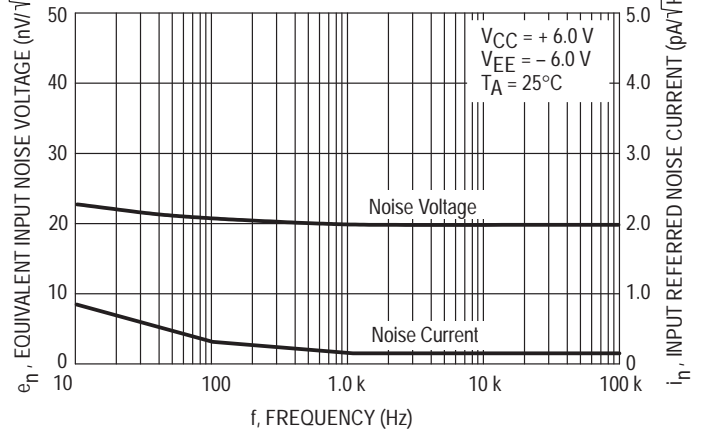

Figure 25. Equivalent Input Noise Voltage and Current versus Frequency





DETAILED OPERATING DESCRIPTION

General Information

The MC33201/2/4 family of operational amplifiers are unique in their ability to swing rail-to-rail on both the input and the output with a completely bipolar design. This offers low noise, high output current capability and a wide common mode input voltage range even with low supply voltages. Operation is guaranteed over an extended temperature range and at supply voltages of 2.0 V, 3.3 V and 5.0 V and ground.

Since the common mode input voltage range extends from  $V_{CC}$  to  $V_{EE}$ , it can be operated with either single or split voltage supplies. The MC33201/2/4 are guaranteed not to latch or phase reverse over the entire common mode range, however, the inputs should not be allowed to exceed maximum ratings.

Circuit Information

Rail-to-rail performance is achieved at the input of the amplifiers by using parallel NPN-PNP differential input stages. When the inputs are within 800 mV of the negative rail, the PNP stage is on. When the inputs are more than 800 mV greater than  $V_{EE}$ , the NPN stage is on. This switching of input pairs will cause a reversal of input bias currents (see Figure 6). Also, slight differences in offset voltage may be noted between the NPN and PNP pairs. Cross-coupling techniques have been used to keep this change to a minimum.

In addition to its rail-to-rail performance, the output stage is current boosted to provide 80 mA of output current, enabling the op amp to drive 600  $\Omega$  loads. Because of this high output current capability, care should be taken not to exceed the 150°C maximum junction temperature.

Figure 26. Noninverting Amplifier Slew Rate

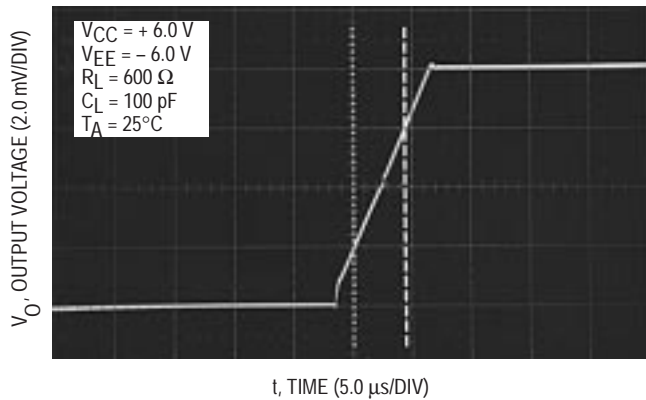

Figure 27. Small Signal Transient Response

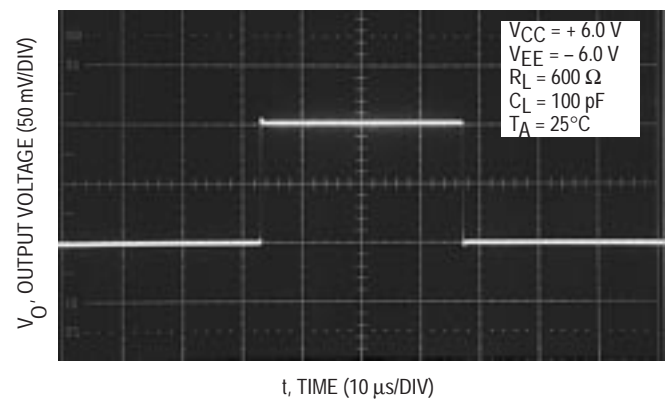
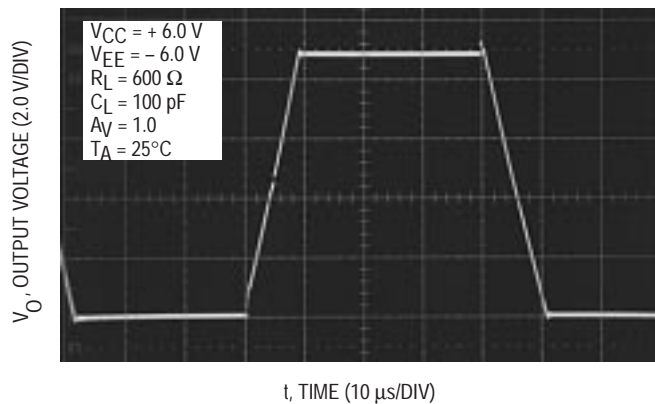

Figure 28. Large Signal Transient Response



# MC33201 MC33202 MC33204

## ORDERING INFORMATION

Operational Amplifier Function	Device	Operating Temperature Range	Package	Shipping
Single	MC33201D	$T_A = -40^\circ \text{ to } +105^\circ\text{C}$	SO-8	98 Units / Rail
	MC33201DR2		SO-8	2500 Units / Tape & Reel
	MC33201P		Plastic DIP	50 Units / Rail
	MC33201VD	$T_A = -40^\circ \text{ to } +125^\circ\text{C}$	SO-8	98 Units / Rail
	MC33201VDR2		SO-8	2500 Units / Tape & Reel
	MC33201VP		Plastic DIP	50 Units / Rail
Dual	MC33202D	$T_A = -40^\circ \text{ to } +105^\circ\text{C}$	SO-8	98 Units / Rail
	MC33202DR2		SO-8	2500 Units / Tape & Reel
	MC33202DMR2		Micro-8	4000 Units / Tape & Reel
	MC33202P		Plastic DIP	50 Units / Rail
	MC33202VD	$T_A = -40^\circ \text{ to } +125^\circ\text{C}$	SO-8	98 Units / Rail
	MC33202VDR2		SO-8	2500 Units / Tape & Reel
	MC33202VP		Plastic DIP	50 Units / Rail
Quad	MC33204D	$T_A = -40^\circ \text{ to } +105^\circ\text{C}$	SO-14	55 Units / Rail
	MC33204DR2		SO-14	2500 Units / Tape & Reel
	MC33204DTB		TSSOP-14	96 Units / Rail
	MC33204DTBR2		TSSOP-14	2500 Units / Tape & Reel
	MC33204P		Plastic DIP	25 Units / Rail
	MC33204VD	$T_A = -40^\circ \text{ to } +125^\circ\text{C}$	SO-14	55 Units / Rail
	MC33204VDR2		SO-14	2500 Units / Tape & Reel
	MC33204VP		Plastic DIP	25 Units / Rail

# MC33201 MC33202 MC33204

## PACKAGE DIMENSIONS

**P SUFFIX**  
 PLASTIC PACKAGE  
 CASE 626-05  
 ISSUE K

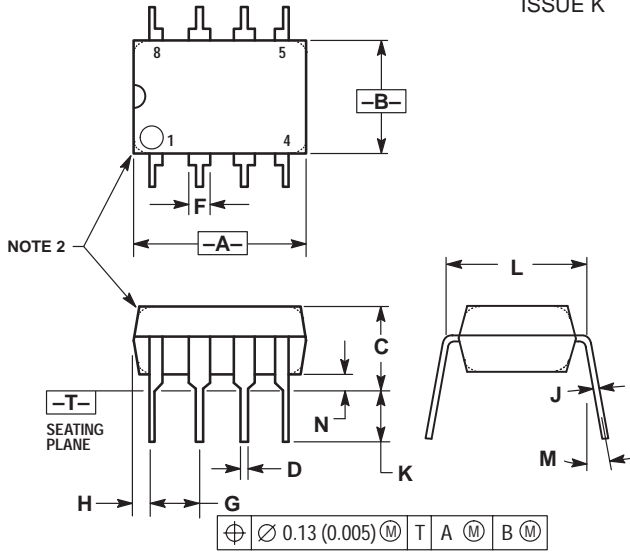

NOTES:

1. DIMENSION L TO CENTER OF LEAD WHEN FORMED PARALLEL.
2. PACKAGE CONTOUR OPTIONAL (ROUND OR SQUARE CORNERS).
3. DIMENSIONING AND TOLERANCING PER ANSI Y14.5M, 1982.

DIM	MILLIMETERS		INCHES	
	MIN	MAX	MIN	MAX
A	9.40	10.16	0.370	0.400
B	6.10	6.60	0.240	0.260
C	3.94	4.45	0.155	0.175
D	0.38	0.51	0.015	0.020
F	1.02	1.78	0.040	0.070
G	2.54 BSC		0.100 BSC	
H	0.76	1.27	0.030	0.050
J	0.20	0.30	0.008	0.012
K	2.92	3.43	0.115	0.135
L	7.62 BSC		0.300 BSC	
M	---	10°	---	10°
N	0.76	1.01	0.030	0.040

**(SO-8)**  
**D SUFFIX**  
 PLASTIC PACKAGE  
 CASE 751-05  
 ISSUE R

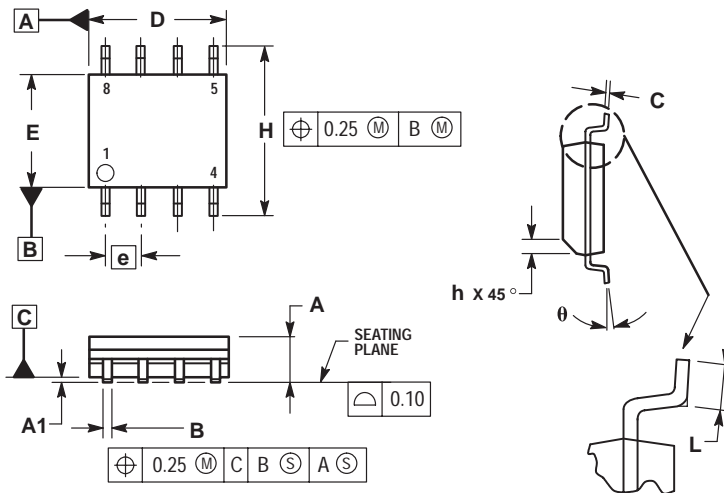

NOTES:

1. DIMENSIONING AND TOLERANCING PER ASME Y14.5M, 1994.
2. DIMENSIONS ARE IN MILLIMETERS.
3. DIMENSION D AND E DO NOT INCLUDE MOLD PROTRUSION.
4. MAXIMUM MOLD PROTRUSION 0.15 PER SIDE.
5. DIMENSION B DOES NOT INCLUDE MOLD PROTRUSION. ALLOWABLE DAMBAR PROTRUSION SHALL BE 0.127 TOTAL IN EXCESS OF THE B DIMENSION AT MAXIMUM MATERIAL CONDITION.

DIM	MILLIMETERS	
	MIN	MAX
A	1.35	1.75
A1	0.10	0.25
B	0.35	0.49
C	0.18	0.25
D	4.80	5.00
E	3.80	4.00
e	1.27 BSC	
H	5.80	6.20
h	0.25	0.50
L	0.40	1.25
$\theta$	0°	7°

# MC33201 MC33202 MC33204

## PACKAGE DIMENSIONS

**P SUFFIX**  
 PLASTIC PACKAGE  
 CASE 646-06  
 ISSUE L

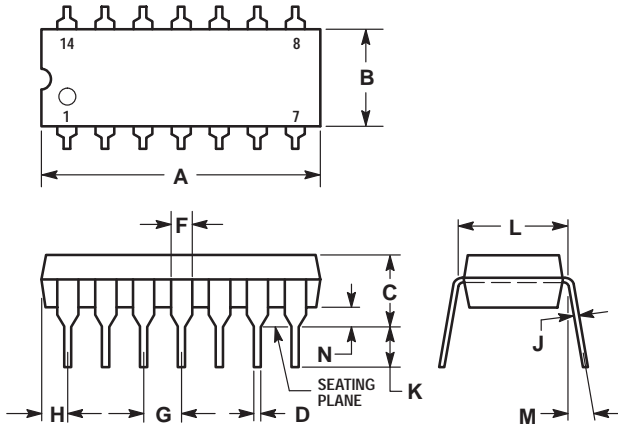

**NOTES:**

- LEADS WITHIN 0.13 (0.005) RADIUS OF TRUE POSITION AT SEATING PLANE AT MAXIMUM MATERIAL CONDITION.
- DIMENSION L TO CENTER OF LEADS WHEN FORMED PARALLEL.
- DIMENSION B DOES NOT INCLUDE MOLD FLASH.
- ROUNDED CORNERS OPTIONAL.

DIM	INCHES		MILLIMETERS	
	MIN	MAX	MIN	MAX
A	0.715	0.770	18.16	19.56
B	0.240	0.260	6.10	6.60
C	0.145	0.185	3.69	4.69
D	0.015	0.021	0.38	0.53
F	0.040	0.070	1.02	1.78
G	0.100 BSC		2.54 BSC	
H	0.052	0.095	1.32	2.41
J	0.008	0.015	0.20	0.38
K	0.115	0.135	2.92	3.43
L	0.300 BSC		7.62 BSC	
M	0°	10°	0°	10°
N	0.015	0.039	0.39	1.01

**(SO-14)**  
**D SUFFIX**  
 PLASTIC PACKAGE  
 CASE 751A-03  
 ISSUE F

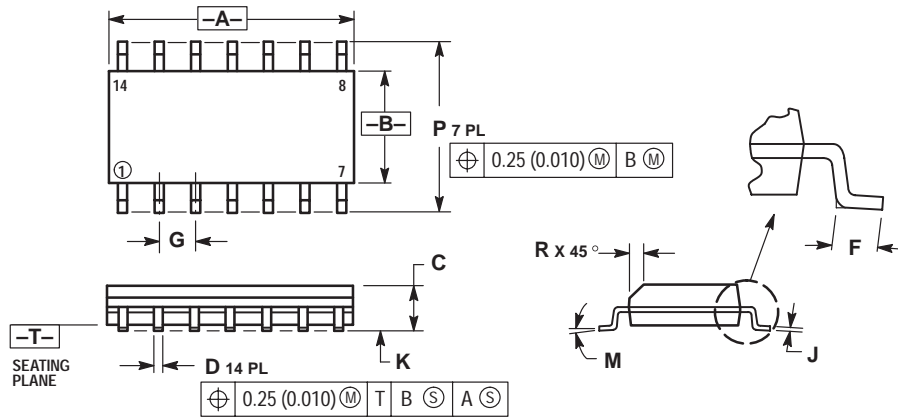

**NOTES:**

- DIMENSIONING AND TOLERANCING PER ANSI Y14.5M, 1982.
- CONTROLLING DIMENSION: MILLIMETER.
- DIMENSIONS A AND B DO NOT INCLUDE MOLD PROTRUSION.
- MAXIMUM MOLD PROTRUSION 0.15 (0.006) PER SIDE.
- DIMENSION D DOES NOT INCLUDE DAMBAR PROTRUSION. ALLOWABLE DAMBAR PROTRUSION SHALL BE 0.127 (0.005) TOTAL IN EXCESS OF THE D DIMENSION AT MAXIMUM MATERIAL CONDITION.

DIM	MILLIMETERS		INCHES	
	MIN	MAX	MIN	MAX
A	8.55	8.75	0.337	0.344
B	3.80	4.00	0.150	0.157
C	1.35	1.75	0.054	0.068
D	0.35	0.49	0.014	0.019
F	0.40	1.25	0.016	0.049
G	1.27 BSC		0.050 BSC	
J	0.19	0.25	0.008	0.009
K	0.10	0.25	0.004	0.009
M	0°	7°	0°	7°
P	5.80	6.20	0.228	0.244
R	0.25	0.50	0.010	0.019

# MC33201 MC33202 MC33204

## PACKAGE DIMENSIONS

(TSSOP-14)  
DTB SUFFIX  
PLASTIC PACKAGE  
CASE 948G-01  
ISSUE O

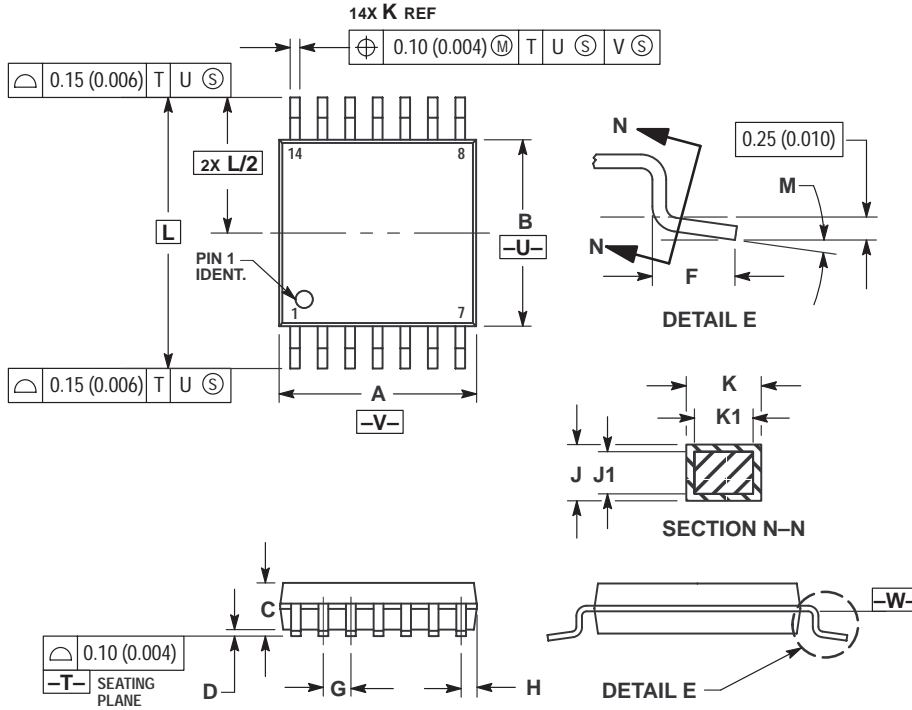

### NOTES:

- DIMENSIONING AND TOLERANCING PER ANSI Y14.5M, 1982.
- CONTROLLING DIMENSION: MILLIMETER.
- DIMENSION A DOES NOT INCLUDE MOLD FLASH, PROTRUSIONS OR GATE BURRS. MOLD FLASH OR GATE BURRS SHALL NOT EXCEED  $0.15 (0.006)$  PER SIDE.
- DIMENSION B DOES NOT INCLUDE INTERLEAD FLASH OR PROTRUSION. INTERLEAD FLASH OR PROTRUSION SHALL NOT EXCEED  $0.25 (0.010)$  PER SIDE.
- DIMENSION K DOES NOT INCLUDE DAMBAR PROTRUSION. ALLOWABLE DAMBAR PROTRUSION SHALL BE  $0.08 (0.003)$  TOTAL IN EXCESS OF THE K DIMENSION AT MAXIMUM MATERIAL CONDITION.
- TERMINAL NUMBERS ARE SHOWN FOR REFERENCE ONLY.
- DIMENSION A AND B ARE TO BE DETERMINED AT DATUM PLANE  $-W-$ .

DIM	MILLIMETERS		INCHES	
	MIN	MAX	MIN	MAX
A	4.90	5.10	0.193	0.200
B	4.30	4.50	0.169	0.177
C	—	1.20	—	0.047
D	0.05	0.15	0.002	0.006
F	0.50	0.75	0.020	0.030
G	0.65 BSC		0.026 BSC	
H	0.50	0.60	0.020	0.024
J	0.09	0.20	0.004	0.008
J1	0.09	0.16	0.004	0.006
K	0.19	0.30	0.007	0.012
K1	0.19	0.25	0.007	0.010
L	6.40 BSC		0.252 BSC	
M	0°		8°	

# MC33201 MC33202 MC33204

## PACKAGE DIMENSIONS

(Micro-8)  
DM SUFFIX  
PLASTIC PACKAGE  
CASE 846A-02  
ISSUE D

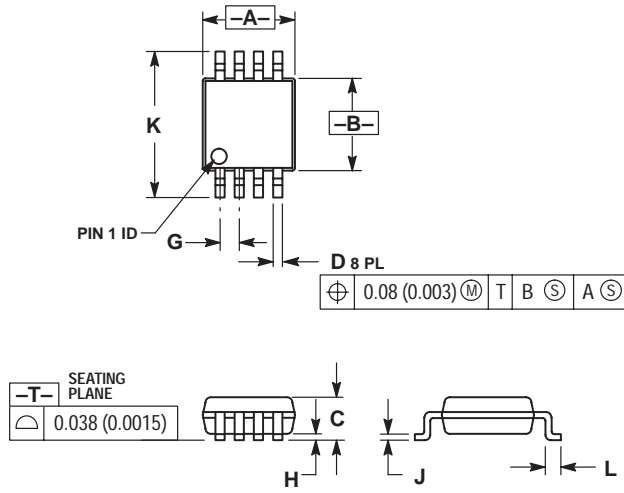

### NOTES:

1. DIMENSIONING AND TOLERANCING PER ANSI Y14.5M, 1982.
2. CONTROLLING DIMENSION: MILLIMETER.
3. DIMENSION A DOES NOT INCLUDE MOLD FLASH, PROTRUSIONS OR GATE BURRS. MOLD FLASH, PROTRUSIONS OR GATE BURRS SHALL NOT EXCEED 0.15 (0.006) PER SIDE.
4. DIMENSION B DOES NOT INCLUDE INTERLEAD FLASH OR PROTRUSION. INTERLEAD FLASH OR PROTRUSION SHALL NOT EXCEED 0.25 (0.010) PER SIDE.

DIM	MILLIMETERS		INCHES	
	MIN	MAX	MIN	MAX
A	2.90	3.10	0.114	0.122
B	2.90	3.10	0.114	0.122
C	---	1.10	---	0.043
D	0.25	0.40	0.010	0.016
G	0.65 BSC		0.026 BSC	
H	0.05	0.15	0.002	0.006
J	0.13	0.23	0.005	0.009
K	4.75	5.05	0.187	0.199
L	0.40	0.70	0.016	0.028

# Notes

**ON Semiconductor** and  are trademarks of Semiconductor Components Industries, LLC (SCILLC). SCILLC reserves the right to make changes without further notice to any products herein. SCILLC makes no warranty, representation or guarantee regarding the suitability of its products for any particular purpose, nor does SCILLC assume any liability arising out of the application or use of any product or circuit, and specifically disclaims any and all liability, including without limitation special, consequential or incidental damages. "Typical" parameters which may be provided in SCILLC data sheets and/or specifications can and do vary in different applications and actual performance may vary over time. All operating parameters, including "Typicals" must be validated for each customer application by customer's technical experts. SCILLC does not convey any license under its patent rights nor the rights of others. SCILLC products are not designed, intended, or authorized for use as components in systems intended for surgical implant into the body, or other applications intended to support or sustain life, or for any other application in which the failure of the SCILLC product could create a situation where personal injury or death may occur. Should Buyer purchase or use SCILLC products for any such unintended or unauthorized application, Buyer shall indemnify and hold SCILLC and its officers, employees, subsidiaries, affiliates, and distributors harmless against all claims, costs, damages, and expenses, and reasonable attorney fees arising out of, directly or indirectly, any claim of personal injury or death associated with such unintended or unauthorized use, even if such claim alleges that SCILLC was negligent regarding the design or manufacture of the part. SCILLC is an Equal Opportunity/Affirmative Action Employer.

## PUBLICATION ORDERING INFORMATION

### North America Literature Fulfillment:

Literature Distribution Center for ON Semiconductor  
P.O. Box 5163, Denver, Colorado 80217 USA  
**Phone:** 303-675-2175 or 800-344-3860 Toll Free USA/Canada  
**Fax:** 303-675-2176 or 800-344-3867 Toll Free USA/Canada  
**Email:** ONlit@hibbertco.com

**N. American Technical Support:** 800-282-9855 Toll Free USA/Canada

**EUROPE:** LDC for ON Semiconductor — European Support

**German Phone:** 303-308-7140 (Mon-Fri 2:30pm to 5:00pm Munich Time)  
**German Email:** ONlit-german@hibbertco.com  
**French Phone:** 303-308-7141 (Mon-Fri 2:30pm to 5:00pm Toulouse Time)  
**French Email:** ONlit-french@hibbertco.com  
**English Phone:** 303-308-7142 (Mon-Fri 1:30pm to 5:00pm UK Time)  
**English Email:** ONlit@hibbertco.com

**ASIA/PACIFIC:** LDC for ON Semiconductor — Asia Support

**Phone:** 303-675-2121 (Tue-Fri 9:00am to 1:00pm, Hong Kong Time)  
Toll Free from Hong Kong 800-4422-3781  
**Email:** ONlit-asia@hibbertco.com

**JAPAN:** ON Semiconductor, Japan Customer Focus Center  
4-32-1 Nishi-Gotanda, Shinagawa-ku, Tokyo, Japan 141-8549

**Phone:** 81-3-5487-8345  
**Email:** r14153@onsemi.com

**Fax Response Line:** 303-675-2167  
800-344-3810 Toll Free USA/Canada

**ON Semiconductor Website:** <http://onsemi.com>

For additional information, please contact your local Sales Representative.