

Rectifiers

In Brief . . .

Continuing investment in research and development for discrete products has created a rectifier manufacturing facility that matches the precision and versatility of the most advanced integrated circuits. As a result, Motorola's silicon rectifiers span all high tech applications with quality levels capable of passing the most stringent environmental tests . . . including those for automotive under-hood applications. Additionally, the introduction of Motorola's first generation GaAs power devices is pushing the limits of today's rectifier technology.

Product Highlights:

- GaAs Rectifiers Power Manager™ with incredibly soft and hyperfast (<15 ns) reverse recovery are ideally suited for high frequency power supplies, free wheeling diodes, and as polarity protection diodes.
- Surface Mount Devices — A major thrust has been the development and introduction of a broad range of power rectifiers, Schottky and Ultrafast, 1/2 amp to 25 amp, 15 to 600 volts.
- Application Specific Rectifiers —
 - MEGAHERTZ™ series for high frequency power supplies and power factor correction.
 - Schottky rectifiers having lower forward voltage drop (0.3 to 0.6 volts) for use in low voltage SMPS outputs and as "OR"ing diodes.
 - Automotive transient suppressors.
- Ultrafast rectifiers having reverse recovery times as low as 25 ns to complement the Schottky devices for higher voltage requirements in high frequency applications.
- A wide variety of package options to match virtually any potential requirement.

The rectifier selector section that follows has generally been arranged by package and technology. The individual tables have been sorted by voltage and current with the package types for the devices listed shown above each table. The Application Specific Rectifiers are also included in their respective tables.

Motorola's commitment to Six-Sigma is showing its worth. Refined processes no longer produce fallout as such and therefore only **Motorola Preferred Devices** are listed in the tables. The non-preferred devices will continue to be offered, but customers are encouraged to begin designing using the preferred types.

	Page
Rectifier Numbering System	5.6-2
Application Specific Rectifiers	5.6-3
Low V_F Schottky	5.6-3
MEGAHERTZ	5.6-3
SCANSWITCH	5.6-3
Automotive Transient Suppressors	5.6-3
SWITCHMODE™ Rectifiers	5.6-4
Surface Mount Schottky	5.6-4
Axial Lead Schottky	5.6-6
TO-220 Type Schottky	5.6-7
TO-218 Types and TO-247 Schottky	5.6-8
POWERTAP II	5.6-9
Ultrafast Rectifiers	5.6-10
Surface Mount Ultrafast	5.6-10
Axial Lead Ultrafast	5.6-10
TO-220 Type Ultrafast	5.6-11
TO-218 Types and TO-247 Ultrafast	5.6-12
POWERTAP II	5.6-12
Fast Recovery Rectifiers/General Purpose Rectifiers	5.6-13
GaAs Rectifiers Power Manager™	5.6-14

RECTIFIER NUMBERING SYSTEM

PART NUMBER KEY

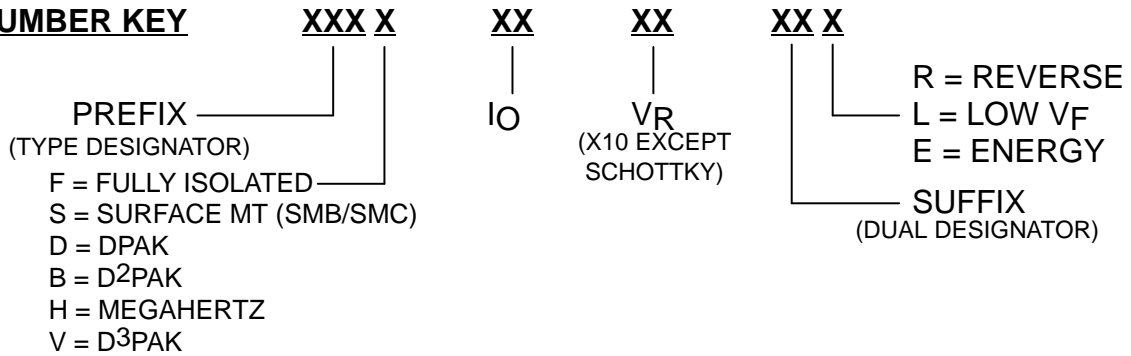

PREFIX KEY

- MUR = MOTOROLA ULTRA FAST RECTIFIER
- MBR = MOTOROLA (SCHOTTKY) BARRIER RECTIFIER
- MGR = MOTOROLA GaAs RECTIFIER
- MR = MOTOROLA STANDARD & FAST RECOVERY

SUFFIX KEY

- CT = CENTER TAP (DUAL) TO-220, TO-3, POWERTAP II
- PT = CENTER TAP (DUAL) TO-218 PACKAGE
- WT = CENTER TAP (DUAL) TO-247 / TO-3P

EXAMPLE:	MUR	30	20	WT
	MOTOROLA ULTRAFAST	30 AMP	200 V	CENTER TAP (DUAL) TO-247
EXAMPLE:	MBR	30	45	WT
	MOTOROLA SCHOTTKY	30 AMP	45 V	CENTER TAP (DUAL) TO-247

Application Specific Rectifiers

The focus for Rectifier Products continues to be on Schottky and Ultrafast technologies, with process and packaging improvements to achieve greater efficiency in high frequency switching power supplies, and high current

mainframe supplies. Our new product thrust is intended to be more “application specific” than in the past, while continuing to strive for broad market acceptance.

Table 1. Low V_F Schottky Rectifiers

State of the art geometry is used in low V_F Schottky devices for improved efficiency in low voltage, high frequency switching power supplies, free-wheeling diodes, polarity protection diodes and “OR”ing diodes.

Device	I_O Amps	V_{RRM} (Volts)	V_F @ Rated I_O and Temperature Volts (Max)	I_R @ Rated V_{RRM} mAmps (Max)	Package
<i>MBR0520LT1</i>	0.5	20	0.33	0.25	SOD-123
<i>MBRS130LT3</i>	1	30	0.395	1	SMB
<i>MBRD835L</i>	8	35	0.41	1.4	DPAK
<i>MBRD1035CTL</i>	10	35	0.41	6	DPAK
<i>MBR2030CTL</i>	20	30	0.48	5	TO-220
<i>MBRB2535CTL</i>	25	35	0.41	10	D ² PAK
<i>MBR2535CTL</i>	25	35	0.41	5	TO-220
<i>MBRB2515L</i>	25	15	0.42	15	D ² PAK
<i>MBR2515L</i>	25	15	0.42	15	TO-220
<i>MBRB3030CTL</i>	30	30	0.58	5	D ² PAK
<i>MBR4015LWT</i>	40	15	0.42	5	TO-247
<i>MBR5025L</i>	50	25	0.58	0.5	TO-218
<i>MBRP20030CTL</i>	200	30	0.39	5	POWERTAP II
<i>MBRP60035CTL</i>	600	35	0.50	10	POWERTAP II

Table 2. MEGAHERTZ Rectifiers

MEGAHERTZ Series — This group of ultrafast rectifiers is designed to provide improved efficiency in very high frequency switching power supplies and for use in power factor correction circuits.

Device	I_O Amps	V_{RRM} (Volts)	Maximum		t_{rr} (Nanosecond)
			V_F @ Rated I_O and Temp. (Volts)	I_R @ Rated V_{RRM} (mAmps)	
<i>MURH840CT/MURHB840CT</i>	8	400	1.7	0.01	28
<i>MURH860CT</i>	8	600	2.0	0.01	28

Table 3. SCANSWITCH Rectifiers

These ultrafast rectifiers are designed for improved performance in very high resolution monitors and work stations where forward recovery time (t_{fr}) and high voltage (1200–1500 volts) are primary considerations.

Device	I_O Amps	V_{RRM} (Volts)	Maximum		$V_{RFM}^{(6)}$ (Volts)
			t_{fr} (Nanoseconds)	t_{rr} (Nanoseconds)	
<i>MUR880E</i>	8	800	—	75	—
<i>MUR10120E</i>	10	1200	175	175	14
<i>MUR10150E</i>	10	1500	175	175	16

Table 4. Automotive Transient Suppressors

Automotive transient suppressors are designed for protection against over-voltage conditions in the auto electrical system including the “LOAD DUMP” phenomenon that occurs when the battery open circuits while the car is running.

Device	I_O Amps	V_{RRM} (Volts)	$V_{(BR)}$ (Volts)	$I_{RSM}^{(7)}$ (Amps)	T (°C)
<i>MR2535L/MR2535S</i>	35	20	24–32	110	175

⁽⁶⁾ V_{RFM} = Maximum Transient Overshoot Voltage.

⁽⁷⁾Time constant = 10 ms, Duty Cycle ≤ 1%, T_C = 25°C.

Devices listed in bold, italic are Motorola preferred devices.

SWITCHMODE™ Rectifiers

Schottky power rectifiers with the high speed and low forward voltage drop characteristic of Schottky's metal/silicon junctions are produced with ruggedness and temperature performance comparable to silicon-junction rectifiers. Ideal for use in low-voltage, high-frequency power supplies, and as very fast clamping diodes, these devices feature switching times less than 10 ns, and are offered in current ranges from 0.5 to 600 amperes, and reverse voltages to 200 volts.

In some current ranges, devices are available with junction temperature specifications of 125°C, 150°C and 175°C. Devices with higher T_J ratings can have significantly lower leakage currents, but higher forward-voltage specifications. These parameter tradeoffs should be considered when selecting devices for applications that can be satisfied by more than one device type number.

All devices are connected cathode-to-case or cathode-to-heatsink, where applicable. Contact your Motorola representative for more information.

There are many other standard features in Motorola Schottky rectifiers that give added performance and reliability.

1. GUARDRINGS were pioneered by Motorola and are included in all Schottky die for reverse voltage stress protection from high rates of dv/dt to virtually eliminate the need for snubber networks. The guardring also operates like a zener and avalanches when subjected to voltage transients.

2. MOLYBDENUM DISCS on both sides of the die minimize fatigue from power cycling in all metal products. Plastic encapsulated devices have a special solder formulation for the same purpose.

3. QUALITY CONTROL monitors all critical fabrication operations and performs selected stress tests to assure constant processes. Motorola's commitment to six sigma has provided significant quality improvement.

Case 425
SOD-123



Cathode = Band

Case 403B-01
SMA



Cathode = Notch

Case 403A
SMB



Cathode = Notch

Case 403
SMC



Cathode = Notch

Table 5. Surface Mount Schottky Rectifiers

V _{RRM} (Volts)	I _O (1) (Amperes)	I _O Rating Condition	Device	Max V _F @ i _F T _C = 25°C (Volts)	I _{FSM} (Amperes)	T _J Max (°C)	Package
20	0.5	T _L = 105°C	<i>MBR0520LT1</i> ★	0.310 @ 0.1 A 0.385 @ 0.5 A	5	125	SOD-123
30	0.5	T _L = 105°C	<i>MBR0530T1</i> ★	0.375 @ 0.1 A 0.430 @ 0.5 A	5	125	SOD-123
40	0.5	T _L = 110°C	<i>MBR0540T1</i> ★	0.53 @ 0.5 A	20	150	SOD-123
30	1	T _L = 100°C	<i>MBRA130LT3</i> ★	0.395 @ 1.0 A	—	125	SMA
40	1	T _L = 100°C	<i>MBRA140T3</i> ★	0.55 @ 1.0 A	—	125	SMA
30	1	T _L = 120°C	<i>MBRS130LT3</i>	0.395 @ 1.0 A	40	125	SMB
40	1	T _L = 115°C	<i>MBRS140T3</i>	0.6 @ 1.0 A	40	125	SMB
100	1	T _L = 120°C	<i>MBRS1100T3</i>	0.75 @ 1.0 A	40	150	SMB
40	3	T _L = 100°C	<i>MBRS340T3</i>	0.525 @ 3.0 A	80	125	SMC
60	3	T _L = 100°C	<i>MBRS360T3</i> ★	0.74 @ 3.0 A	80	125	SMC

(1) I_O is total device current capability.

★ New Product

Devices listed in bold, italic are Motorola preferred devices.

Case 433-01
D³PAK



Case 369A
DPAK
Style 3

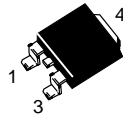

Case 418B
D²PAK
Style 3

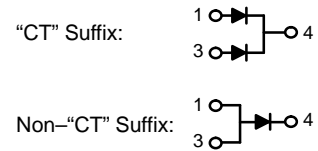
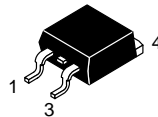

Table 5. Surface Mount Schottky Rectifiers (continued)

V _{RRM} (Volts)	I _O (1) (Amperes)	I _O Rating Condition	Device	Max V _F @ i _F T _C = 25°C (Volts)	I _{FSM} (Amperes)	T _J Max (°C)	Package
40	3	T _C = 125°C	<i>MBRD340</i>	0.60 @ 3.0 A	75	150	DPAK
60	3	T _C = 125°C	<i>MBRD360</i>	0.60 @ 3.0 A	75	150	DPAK
40	6	T _C = 130°C	<i>MBRD640CT</i>	0.70 @ 3.0 A	75	150	DPAK
60	6	T _C = 130°C	<i>MBRD660CT</i>	0.70 @ 3.0 A	75	150	DPAK
35	8	T _C = 100°C	<i>MBRD835L</i> ★	0.40 @ 3.0 A 0.51 @ 8.0 A	100	125	DPAK
35	10	T _C = 90°C	<i>MBRD1035CTL</i> ★	0.49 @ 10 A	100	125	DPAK
45	15	T _C = 105°C	<i>MBRB1545CT</i>	0.84 @ 15 A	150	150	D ² PAK
60	20	T _C = 110°C	<i>MBRB2060CT</i>	0.95 @ 20 A	150	150	D ² PAK
100	20	T _C = 110°C	<i>MBRB20100CT</i>	0.85 @ 10 A 0.95 @ 20 A	150	150	D ² PAK
200	20	T _C = 125°C	<i>MBRB20200CT</i> ★	1.0 @ 20 A	150	150	D ² PAK
15	25	T _C = 90°C	<i>MBRB2515L</i> ★	0.45 @ 25 A	150	100	D ² PAK
35	25	T _C = 110°C	<i>MBRB2535CTL</i>	0.47 @ 12.5 A 0.55 @ 25 A	150	125	D ² PAK
45	25	T _C = 130°C	<i>MBRB2545CT</i>	0.82 @ 30 A	150	150	D ² PAK
30	30	T _C = 115°C	<i>MBRB3030CT</i> ★	0.51 @ 15 A 0.62 @ 30 A	300	150	D ² PAK
30	30	T _C = 95°C	<i>MBRB3030CTL</i> ★	0.45 @ 15 A 0.51 @ 30 A	150	125	D ² PAK
30	40	T _C = 110°C	<i>MBRB4030</i> ★	0.46 @ 20 A 0.55 @ 40 A	300	150	D ² PAK
30	70	T _C = 90°C	<i>MBRV7030CTL</i> ★	0.5 @ 35 A 0.62 @ 70 A	500	150	D ³ PAK

(1) I_O is total device current capability.

★ New Product

Devices listed in bold, italic are Motorola preferred devices.

Case 59-04
Plastic



Cathode = Polarity Band

Case 267-03
Plastic



Cathode = Polarity Band

Table 6. Axial Lead Schottky Rectifiers

V _{RRM} (Volts)	I _O (Amperes)	I _O Rating Condition	Device	Max V _F @ i _F T _C = 25°C (Volts)	I _{FSM} (Amperes)	T _J Max (°C)	Case
20	1	T _A = 55°C R _{θJA} = 80°C/W	1N5817	0.45 @ 1.0 A	25	125	59-04
30	1	T _A = 55°C R _{θJA} = 80°C/W	1N5818	0.55 @ 1.0 A	25	125	59-04
40	1	T _A = 55°C R _{θJA} = 80°C/W	1N5819	0.60 @ 1.0 A	25	125	59-04
60	1	T _A = 55°C R _{θJA} = 80°C/W	MBR160	0.75 @ 1.0 A	25	150	59-04
100	1	T _A = 120°C R _{θJA} = 50°C/W	MBR1100	0.79 @ 1.0 A	50	150	59-04
20	3	T _A = 76°C R _{θJA} = 28°C/W	1N5820	0.457 @ 3.0 A	80	125	267-03
30	3	T _A = 71°C R _{θJA} = 28°C/W	1N5821	0.500 @ 3.0 A	80	125	267-03
40	3	T _A = 61°C R _{θJA} = 28°C/W	1N5822	0.525 @ 3.0 A	80	125	267-03
40	3	T _A = 65°C R _{θJA} = 28°C/W	MBR340	0.600 @ 3.0 A	80	150	267-03
60	3	T _A = 65°C R _{θJA} = 28°C/W	MBR360	0.740 @ 3.0 A	80	150	267-03
100	3	T _A = 100°C R _{θJA} = 28°C/W	MBR3100	0.79 @ 3.0 A	150	150	267-03

Devices listed in bold, italic are Motorola preferred devices.

Case 221B
(TO-220AC)

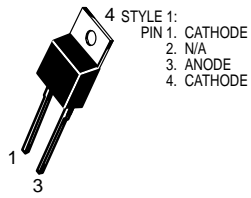

Case 221A-06
(TO-220AB)

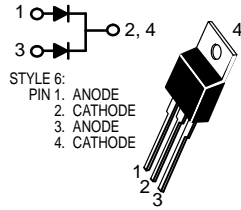

Case 221E

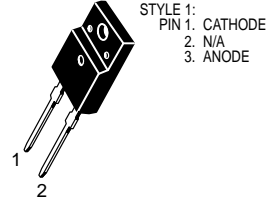

Case 221D

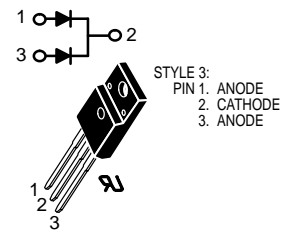









Table 7. TO-220 Type Schottky Rectifiers

V _{RRM} (Volts)	I _O (Amperes)	I _O Rating Condition	Device	Max V _F @ i _F T _C = 25°C (Volts)	I _{FSM} (Amperes)	T _J Max (°C)	Case
45	15	T _C = 105°C	<i>MBR1545CT</i>	0.84 @ 15 A	150	150	221A-06
30	20	T _C = 137°C	<i>MBR2030CTL</i> ★	0.52 @ 10 A 0.58 @ 20 A	150	150	221A-06
45	20	T _C = 135°C	<i>MBR2045CT</i>	0.84 @ 20 A	150	150	221A-06
60	20	T _C = 133°C	<i>MBR2060CT</i>	0.85 @ 10 A 0.95 @ 20 A	150	150	221A-06
100	20	T _C = 133°C	<i>MBR20100CT</i>	0.85 @ 10 A 0.95 @ 20 A	150	150	221A-06
200	20	T _C = 125°C	<i>MBR20200CT</i>	1.0 @ 20 A	150	150	221A-06
15	25	T _C = 90°C	<i>MBR2515L</i> ★	0.45 @ 25 A	150	100	221A-06
35	25	T _C = 95°C	<i>MBR2535CTL</i> ★	0.55 @ 25 A	150	125	221A-06
45	25	T _C = 130°C	<i>MBR2545CT</i>	0.82 @ 30 A	150	150	221A-06
45	30	T _C = 130°C	<i>MBR3045ST</i> ★	0.76 @ 30 A	150	150	221A-06
45	7.5	T _C = 105°C	<i>MBR745</i>	0.84 @ 15 A	150	150	221B
45	10	T _C = 135°C	<i>MBR1045</i>	0.84 @ 20 A	150	150	221B
60	10	T _C = 133°C	<i>MBR1060</i>	0.80 @ 10 A	150	150	221B
100	10	T _C = 133°C	<i>MBR10100</i>	0.80 @ 10 A	150	150	221B
45	16	T _C = 125°C	<i>MBR1645</i>	0.63 @ 16 A	150	150	221B
45	15	T _C = 105°C	 <i>MBRF1545CT</i>	0.84 @ 15 A	150	150	ISOLATED 221D
45	20	T _C = 135°C	 <i>MBRF2045CT</i>	0.84 @ 20 A	150	150	ISOLATED 221D
60	20	T _C = 133°C	 <i>MBRF2060CT</i>	0.95 @ 20 A	150	150	ISOLATED 221D
100	20	T _C = 133°C	 <i>MBRF20100CT</i>	0.95 @ 20 A	150	150	ISOLATED 221D
200	20	T _C = 125°C	 <i>MBRF20200CT</i>	1.0 @ 20 A	150	150	ISOLATED 221D
45	25	T _C = 125°C	 <i>MBRF2545CT</i>	0.82 @ 25 A	150	150	ISOLATED 221D
45	7.5	T _C = 105°C	<i>MBRF745</i> ★	0.84 @ 15 A	150	150	ISOLATED 221E
45	10	T _C = 135°C	<i>MBRF1045</i> ★	0.84 @ 20 A	150	150	ISOLATED 221E

 Indicates UL Recognized — File #E69369

★ New Product

Devices listed in bold, italic are Motorola preferred devices.

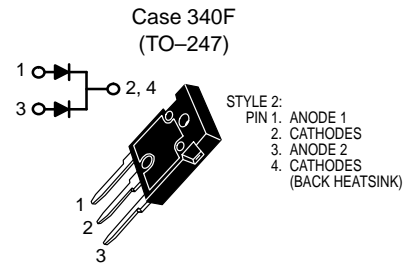
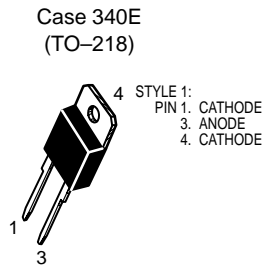
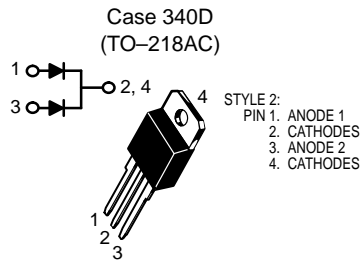
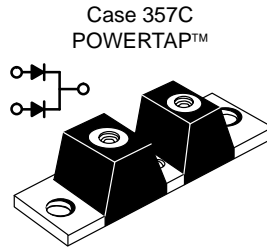

Table 8. TO-218 Types and TO-247 Schottky Rectifiers

V_{RRM} (Volts)	I_O (Amperes)	I_O Rating Condition	Device	Max V_F @ I_F $T_C = 25^\circ\text{C}$ (Volts)	I_{FSM} (Amperes)	T_J Max ($^\circ\text{C}$)	Case
45	30	$T_C = 105^\circ\text{C}$	<i>MBR3045PT</i>	0.76 @ 30 A	200	150	340D
45	40	$T_C = 125^\circ\text{C}$	<i>MBR4045PT</i>	0.70 @ 20 A 0.80 @ 40 A	400	150	340D
45	60	$T_C = 125^\circ\text{C}$	<i>MBR6045PT</i> *	0.62 @ 30 A 0.75 @ 60 A	500	150	340D
25	50	$T_C = 125^\circ\text{C}$	<i>MBR5025L</i> *	0.54 @ 30 A 0.62 @ 50 A	300	150	340E
45	30	$T_C = 105^\circ\text{C}$	<i>MBR3045WT</i>	0.76 @ 30 A	200	150	340F
15	40	$T_C = 125^\circ\text{C}$	<i>MBR4015LWT</i>	0.42 @ 20 A 0.50 @ 40 A	400	150	340F
45	40	$T_C = 125^\circ\text{C}$	<i>MBR4045WT</i>	0.70 @ 20 A 0.80 @ 40 A	400	150	340F
45	60	$T_C = 125^\circ\text{C}$	<i>MBR6045WT</i>	0.62 @ 30 A 0.75 @ 60 A	500	150	340F
30	70	$T_C = 135^\circ\text{C}$	<i>MBR7030WT</i>	0.55 @ 35 A 0.72 @ 70 A	400	150	340F

* New Product

Devices listed in bold, italic are Motorola preferred devices.



Cathode = Mounting Plate
Anode = Terminal

Table 9. POWER TAP II

V_{RRM} (Volts)	$I_O^{(1)}$ (Amperes)	I_O Rating Condition	Device	Max V_F @ i_F $T_C = 25^\circ\text{C}$ (Volts)	I_{FSM} (Amperes)	T_J Max ($^\circ\text{C}$)	Case
30	200	$T_C = 125^\circ\text{C}$	<i>MBRP20030CTL</i> ★	0.52 @ 100 A 0.60 @ 200 A	1500	150	357C
45	200	$T_C = 125^\circ\text{C}$	<i>MBRP20045CT</i> ★	0.78 @ 100 A	1500	175	357C
60	200	$T_C = 125^\circ\text{C}$	<i>MBRP20060CT</i> ★	0.800 @ 100 A	1500	175	357C
45	300	$T_C = 120^\circ\text{C}$	<i>MBRP30045CT</i> ★	0.70 @ 150 A 0.82 @ 300 A	2500	175	357C
60	300	$T_C = 120^\circ\text{C}$	<i>MBRP30060CT</i> ★	0.79 @ 150 A 0.89 @ 300 A	2500	175	357C
35	600	$T_C = 100^\circ\text{C}$	<i>MBRP60035CTL</i> ★	0.57 @ 300 A	4000	150	357C

(1) I_O is total device current capability.

All POWER TAP devices were converted to the new, more rugged, POWER TAP II configuration beginning January 1994. Contact your Motorola representative for more details.

★ New Product

Devices listed in bold, italic are Motorola preferred devices.

Ultrafast Rectifiers

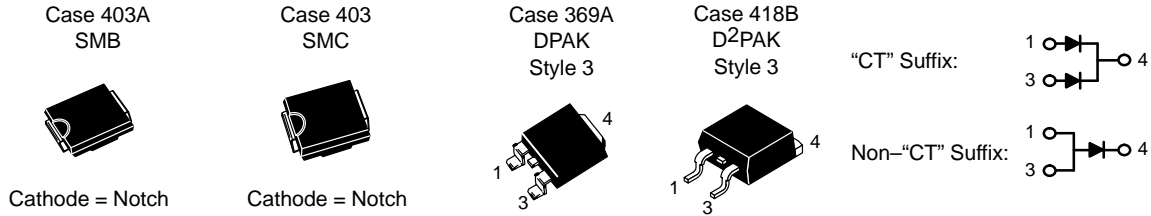

Table 10. Surface Mount Ultrafast Rectifiers

V _{RRM} (Volts)	I _O ⁽¹⁾ (Amperes)	I _O Rating Condition	Device	Max t _{rr} (ns)	Max V _F @ i _F T _C = 25°C (Volts)	I _{FSM} (Amperes)	T _J Max (°C)	Package
200	1	T _L = 155°C	MURS120T3	35	0.875 @ 1.0 A	40	175	SMB
600	1	T _L = 150°C	MURS160T3	75	1.25 @ 1.0 A	35	175	SMB
200	3	T _L = 140°C	MURS320T3	35	0.875 @ 3.0 A	75	175	SMC
600	3	T _L = 130°C	MURS360T3	75	1.25 @ 3.0 A	75	175	SMC
200	3	T _L = 158°C	MURD320	35	0.95 @ 3.0 A	75	175	DPAK
200	6	T _L = 145°C	MURD620CT	35	1.0 @ 3.0 A	63	175	DPAK
400	8	T _L = 120°C	MURHB840CT ★	28	2.2 @ 4.0 A	100	175	D ² PAK
200	16	T _L = 150°C	MURB1620CT	35	0.975 @ 8.0 A	100	175	D ² PAK
600	16	T _L = 150°C	MURB1660CT	60	1.5 @ 8.0 A	100	175	D ² PAK

(1) I_O is total device current capability.

★ New Product

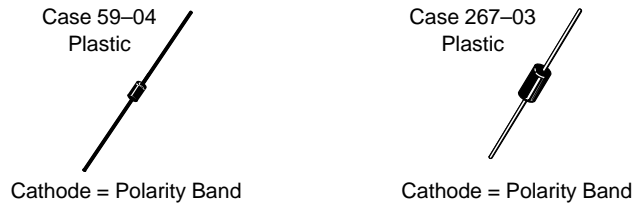
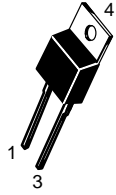

Table 11. Axial Lead Ultrafast Rectifiers

V _{RRM} (Volts)	I _O (Amperes)	I _O Rating Condition	Device	Max t _{rr} (ns)	Max V _F @ i _F T _C = 25°C (Volts)	I _{FSM} (Amperes)	T _J Max (°C)	Case
200	1	T _A = 130°C R _{θJA} = 50°C/W	MUR120	25	0.875 @ 1.0 A	35	175	59-04
600	1	T _A = 120°C R _{θJA} = 50°C/W	MUR160	50	1.25 @ 1.0 A	35	175	59-04
1000	1	T _A = 95°C R _{θJA} = 50°C/W	MUR1100E	75	1.75 @ 1.0 A	35	175	59-04
200	4	T _A = 80°C R _{θJA} = 28°C/W	MUR420	25	0.875 @ 3.0 A	125	175	267-03
600	4	T _A = 40°C R _{θJA} = 28°C/W	MUR460	50	1.25 @ 3.0 A	70	175	267-03
1000	4	T _A = 35°C R _{θJA} = 28°C/W	MUR4100E	75	1.75 @ 3.0 A	70	175	267-03

Devices listed in bold, italic are Motorola preferred devices.

Case 221B
(TO-220AC)



STYLE 1:
PIN 1: CATHODE
2: N/A
3: ANODE
4: CATHODE

Case 221A-06
(TO-220AB)

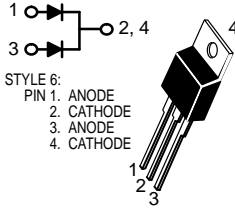

STYLE 6:
PIN 1: ANODE
2: CATHODE
3: ANODE
4: CATHODE

STYLE 7:
PIN 1: CATHODE
2: ANODE
3: CATHODE
4: ANODE

Case 221E

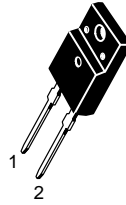

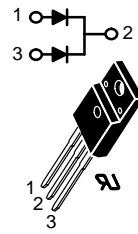

STYLE 1:
PIN 1: CATHODE
2: N/A
3: ANODE

Case 221D



STYLE 3:
PIN 1: ANODE
2: CATHODE
3: ANODE

Table 12. TO-220 Type Ultrafast Rectifiers

V _{RRM} (Volts)	I _O (Amperes)	I _O Rating Condition	Device	Max t _{rr} (ns)	Max V _F @ i _F T _C = 25°C (Volts)	I _{FSM} (Amperes)	T _J Max (°C)	Case
200	6	T _C = 130°C	MUR620CT	35	0.975 @ 3.0 A	75	175	221A-06
400	8	T _C = 120°C	MURH840CT	28	2.0 @ 4.0 A	100	175	221A-06
600	8	T _C = 120°C	MURH860CT	35	2.8 @ 4.0 A	100	175	221A-06
200	16	T _C = 150°C	MUR1620CT	35	0.975 @ 8.0 A	100	175	221A-06
200	16	T _C = 160°C	MUR1620CTR	85	1.2 @ 8.0 A	100	175	221A-06
400	16	T _C = 150°C	MUR1640CT	60	1.30 @ 8.0 A	100	175	221A-06
600	16	T _C = 150°C	MUR1660CT	60	1.5 @ 8.0 A	100	175	221A-06
200	8	T _C = 150°C	MUR820	35	0.975 @ 8.0 A	100	175	221B
400	8	T _C = 150°C	MUR840 ★	50	1.30 @ 8.0 A	100	175	221B
600	8	T _C = 150°C	MUR860 ★	50	1.50 @ 8.0 A	100	175	221B
800	8	T _C = 175°C	MUR880E	75	1.80 @ 8.0 A	100	175	221B
1000	8	T _C = 150°C	MUR8100E	75	1.80 @ 8.0 A	100	175	221B
1200	10	T _C = 125°C	MUR10120E	175	2.2 @ 6.5 A	100	125	221B
1500	10	T _C = 125°C	MUR10150E	175	2.4 @ 6.5 A	100	125	221B
200	15	T _C = 150°C	MUR1520	35	1.05 @ 15 A	200	175	221B
400	15	T _C = 150°C	MUR1540	60	1.25 @ 15 A	150	175	221B
600	15	T _C = 145°C	MUR1560	60	1.50 @ 15 A	150	175	221B
200	8	T _C = 150°C	MURF820 ★	25	0.975 @ 8.0 A	100	150	ISOLATED 221E
200	16	T _C = 150°C	 MURF1620CT ★	25	0.975 @ 8.0 A	100	150	ISOLATED 221D
600	16	T _C = 150°C	 MURF1660CT ★	50	1.50 @ 8.0 A	100	150	ISOLATED 221D

 Indicates UL Recognized — File #E69369

★ New Product

Devices listed in bold, italic are Motorola preferred devices.

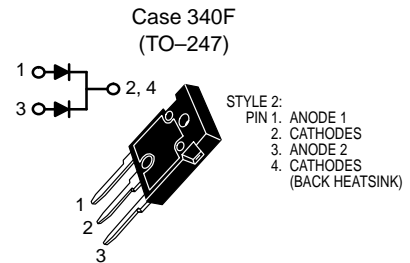
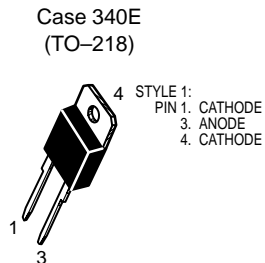
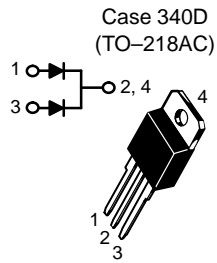

Table 13. TO-218 Types and TO-247 Ultrafast Rectifiers

V _{RRM} (Volts)	I _O (Amperes)	I _O Rating Condition	Device	Max t _{rr} (ns)	Max V _F @ i _F T _C = 25°C (Volts)	I _{FSM} (Amperes)	T _J Max (°C)	Case
200	30	T _C = 145°C	MUR3020WT	35	1.05 @ 15 A	150	175	340F
400	30	T _C = 145°C	MUR3040WT	60	1.25 @ 15 A	150	175	340F
600	30	T _C = 145°C	MUR3060WT	60	1.70 @ 15 A	150	175	340F
200	30	T _C = 150°C	MUR3020PT	35	1.12 @ 15 A	200	175	340D
400	30	T _C = 150°C	MUR3040PT	60	1.12 @ 15 A	150	175	340D
600	30	T _C = 145°C	MUR3060PT	60	1.20 @ 15 A	150	175	340D
400	30	T _C = 70°C	MUR3040 ★	100	1.5 @ 30 A	300	175	340E
800	30	T _C = 70°C	MUR3080 ★	110	1.90 @ 30 A	300	175	340E
400	60	T _C = 70°C	MUR6040	100	1.50 @ 60 A	600	175	340E

★ New Product

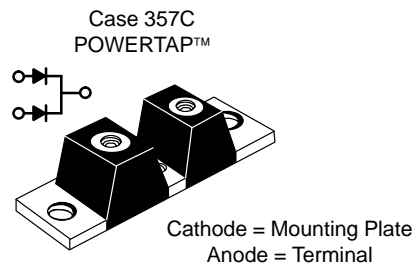

Table 14. POWERTAP II

V _{RRM} (Volts)	I _O (1) (Amperes)	I _O Rating Condition	Device	Max t _{rr} (ns)	Max V _F @ i _F T _C = 25°C (Volts)	I _{FSM} (Amperes)	T _J Max (°C)	Case
200	200	T _C = 130°C	MURP20020CT ★	50	1.00 @ 100 A	800	175	357C
400	200	T _C = 100°C	MURP20040CT ★	50	1.30 @ 100 A	800	175	357C

(1) I_O is total device current capability.

All POWERTAP devices were converted to the new, more rugged, POWERTAP II configuration beginning January 1994. Contact your Motorola representative for more details.

Ⓜ Indicates UL Recognized — File #E69369

★ New Product

Devices listed in bold, italic are Motorola preferred devices.

Fast Recovery Rectifiers/General-Purpose Rectifiers

Axial lead Fast Recovery Rectifiers having maximum switching times of 200 ns and low cost general purpose rectifiers are listed in the table below.

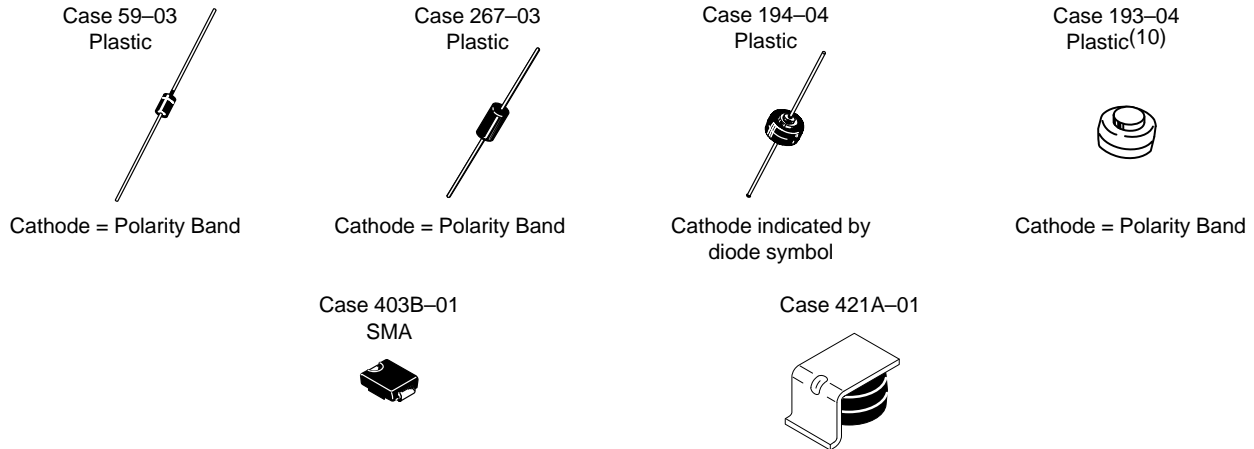

Table 15. Fast Recovery Rectifiers/General Purpose Rectifiers

VRRM (Volts)	IO (Amperes)	IO Rating Condition	Device	Max VF @ iF TJ = 25°C (Volts)	Max trr (ns)	IFSM (Amperes)	TJ Max (°C)	Case
200	1	TC = 100°C	<i>MRA4003</i>	1.1 @ 1.0 A	—	30	150	403B-01
400	1	TC = 100°C	<i>MRA4004</i>	1.1 @ 1.0 A	—	30	150	
600	1	TC = 100°C	<i>MRA4005</i>	1.1 @ 1.0 A	—	30	150	
800	1	TC = 100°C	<i>MRA4006</i>	1.1 @ 1.0 A	—	30	150	
1000	1	TC = 100°C	<i>MRA4007</i>	1.1 @ 1.0 A	—	30	150	
400	1	TA = 75°C	<i>1N4004</i>	1.1 @ 1.0 A	—	30	150	59-03(9)
1000	1	TA = 75°C	<i>1N4007</i>	1.1 @ 1.0 A	—	30	150	
200	1	TA = 75°C	<i>1N4935</i>	1.2 @ 3.14 A TJ = 125°C	200	30	150	
600	1	TA = 75°C	<i>1N4937</i>	1.2 @ 3.14 A TJ = 125°C	200	30	150	
400	3	TL = 105°C	<i>1N5404</i>	1.2 @ 9.4 A	—	200	150	267-03
600	3	TL = 105°C	<i>1N5406</i>	1.2 @ 9.4 A	—	200	150	
200	3	TA = 80°C(10)	<i>MR852</i>	1.25 @ 3.0 A	200	100	150	
600	3	TA = 80°C(10)	<i>MR856</i>	1.25 @ 3.0 A	200	100	150	194-04
400	6	TA = 60°C RθJA = 25°C/W	<i>MR754</i>	1.25 @ 100 A	—	400	175	
1000	6	TA = 60°C RθJA = 25°C/W	<i>MR760</i>	1.25 @ 100 A	—	400	175	193-04
400	25	TC = 150°C	<i>MR2504</i>	1.18 @ 78.5 A	—	400	175	
1000	25	TC = 150°C	<i>MR2510</i>	1.18 @ 78.5 A	—	400	175	421A-01
20	35	TC = 150°C	<i>MR2535S</i>	1.1 @ 100 A	—	400	175	
20	35	TC = 150°C	<i>MR2535L</i> (11)	1.1 @ 100 A	—	400	175	194-04
200	1	TL = 100°C	<i>MRA4935T3</i>	1.1 @ 1.0 A	200	30	150	403B-01
400	1	TL = 100°C	<i>MRA4936T3</i>	1.1 @ 1.0 A	200	30	150	
600	1	TL = 100°C	<i>MRA4937T3</i>	1.1 @ 1.0 A	200	30	150	

(2) VRRM unless noted

(3) VRRM, TJ = 100°C unless noted

(9) Package Size: 0.120" max diameter by 0.260" length.

(10) Must be derated for reverse power dissipation. See data sheet.

(11) Overvoltage Transient Suppressor: 24 – 32 volts avalanche voltage.

Devices listed in bold, italic are Motorola preferred devices.

GaAs Rectifiers Power Manager™

For use in state-of-the-art high power density DC-DC converters and high frequency power supplies, GaAs power rectifiers have several unique characteristics that make them superior to Si-based devices. In particular, GaAs devices are acclaimed for their hyperfast and soft reverse recovery characteristics with low stored charge. Also, the device parameters are stable over a wide temperature range.

GaAs devices as drop-in replacements for Si may eliminate the need for a snubber network or allow for a significant reduction in network size. Performance improvements can therefore be achieved while reducing circuit size (increasing power density), decreasing EMI, and enhancing overall system efficiency.

Table 16. TO-220 and D²PAK GaAs Rectifiers Power Manager™

V _{RRM} (Volts)	I _{DC} (12)	I _{DC} Rating Condition	Device	Max V _F @ 10 A T _C = 25°C (Volts)	Max t _{rr} (ns)	Case
180	10	T _C = 110°C	<i>MGR1018</i> ★	1.4	15	221A-06
180	10	T _C = 110°C	<i>MGRB1018</i> ★	1.4	15	418B
180	20	T _C = 130°C	<i>MGR2018CT</i> ★	1.4	15	221A-06
180	20	T _C = 130°C	<i>MGRB2018CT</i> ★	1.4	15	418B
250	20	T _C = 95°C	<i>MGR2025CT</i> ★	2.2	15	221A-06
250	20	T _C = 95°C	<i>MGRB2025CT</i> ★	2.2	15	418B

(12) I_{DC} is total device current capability.

★ New Product

Case 418B available in reel of 800 "T4".

Devices listed in bold, italic are Motorola preferred devices.