

# Intel® Server System SR2612UR

## *Spares/Accessories List and Configuration Guide*

A reference guide to assist customers in ordering the necessary components to configure the Intel® Server System SR2612UR.



Revision 2.3

April 2011

Enterprise Platforms and Services Marketing

## Revision History

June '09 – Rev0.6 – First Revision.

Aug '09 – Rev 1.0 – Initial public release.

Aug '09 – Rev 1.3 – Added Rack Bracket to included list, MM#s and UPC codes.

Aug '09 – Rev 1.4 – Added additional accessory pictures.

Nov '09 – Rev 1.5 – Added VMware vSphere\* Virtualization Software.

Jan '10 – Rev 1.6 – Product Code and MM number refresh for chipset stepping change.

Feb '10 – Rev 1.7 – Updated system UPC codes. Added MiniSAS cable accessory.

Mar '10 – Rev 1.8 – Updated MiniSAS cable accessory picture.

Mar '10 – Rev 1.9 – Updated images of Spares and Accessories.

July '10 – Rev 2.0 – Updated description of SAS module.

Nov '10 – Rev 2.1 – Added RAID Options. Added 4 modules: AXXRMS2LL040, AXXRMS2LL080, AXXRMS2AF040 and AXXRMS2AF080.

Dec '10 – Rev 2.2 – Added Bezel Options. Updated FAN spare picture.

Apr '11 – Rev 2.3 – Added RS2PI008, RS2PI008DE, RS2BL080SNGL and AXXRSBBU8.

## Disclaimer

INFORMATION IN THIS DOCUMENT IS PROVIDED IN CONNECTION WITH INTEL® PRODUCTS. NO LICENSE, EXPRESS OR IMPLIED, BY ESTOPPEL OR OTHERWISE, TO ANY INTELLECTUAL PROPERTY RIGHTS IS GRANTED BY THIS DOCUMENT. EXCEPT AS PROVIDED IN INTEL'S TERMS AND CONDITIONS OF SALE FOR SUCH PRODUCTS, INTEL ASSUMES NO LIABILITY WHATSOEVER, AND INTEL DISCLAIMS ANY EXPRESS OR IMPLIED WARRANTY, RELATING TO SALE AND/OR USE OF INTEL PRODUCTS INCLUDING LIABILITY OR WARRANTIES RELATING TO FITNESS FOR A PARTICULAR PURPOSE, MERCHANTABILITY, OR INFRINGEMENT OF ANY PATENT, COPYRIGHT OR OTHER INTELLECTUAL PROPERTY RIGHT.

Intel products are not intended for use in medical, life saving, life sustaining applications. Intel may make changes to specifications and product descriptions at any time, without notice.

Intel server boards, server chassis, and processors may contain design defects or errors known as errata, which may cause the product to deviate from published specifications. Current characterized errata are available on request.

Intel, Intel Xeon, Pentium, and the Intel logo are trademarks or registered trademarks of Intel Corporation or its subsidiaries in the United States and other countries.

\*Other names and brands may be claimed as the property of others.

Copyright © 2011, Intel Corporation

## CONTENTS:

REVISION HISTORY .....	2
CONTENTS:.....	3
SYSTEM PRODUCT ORDER CODES .....	4
1.1    PRODUCT DESCRIPTIONS – OVERVIEW .....	4
1.2    BOARD AND SYSTEM PRODUCT ORDER CODES .....	4
SPARES AND ACCESSORIES ORDER CODES .....	6
1.3    I/O MODULES.....	6
1.4    SYSTEM SPARES AND ACCESSORIES .....	8
1.5    BEZEL .....	9
1.6    POWER SUB-SYSTEM SPARES.....	10
1.7    RISER SPARES AND ACCESSORIES.....	10
1.8    INTEL® RAID CONTROLLER OPTIONS:.....	11
VMWARE VSPHERE* VIRTUALIZATION SOFTWARE CONFIGURATION GUIDE FOR VSPHERE* SKUS. <b>14</b>	
1.9    PRODUCT DESCRIPTIONS – OVERVIEW .....	14
1.10   VMWARE VSPHERE* AND vCENTER* SERVER SKUS .....	14

## 1.1 Product Descriptions - Overview

System Product based on the Intel® Server Board S5520UR will be offered as one SKU at production:

**Intel® Server System SR2612UR\* (Integrated SKU).** Customer orders an integrated system. The system is complete, except for the RAID option which will require customer to purchase one of our RAID solutions, and perhaps a cable (see details below).

The cable accessory ASR2612SASCBL is required when RAID option SRCASJV, SRCASLS4I, RS2BL040, RS2BL080, RS2BL080DE, RS2BL080SNGL or RS2MB044 is selected.

System does not include Processors, DDR3 main memory, hard drives, and other customer configuration items.

\* Chassis will not be offered separately.

## 1.2 Board and System Product Order Codes

**Not included in systems:** Processors, DDR3 main memory, hard drives, and other customer configuration items are not included in below SKUs.



Image	Product Code MM UPC	Description	Minimum Order Quantity
	BB5520URR 905485 00735858213493	Intel® Server Board S5520UR with Intel® 5520 C2 stepping chipset. (shipped in bulk pack of 10)	10
	SR2612URR 906554 00735858214452	<p><b>Intel® Server System SR2612UR</b> <b>Includes:</b></p> <ul style="list-style-type: none"> <li>▪ Intel® Server Board S5520UR with Intel® 5520 C2 stepping chipset</li> <li>▪ Intel Server Chassis SR2612</li> <li>▪ Backplane with SAS expander</li> <li>▪ Rack Bracket</li> <li>▪ 12 3.5" fixed HDD sleds</li> <li>▪ 4 non-redundant non-hotswap fans</li> <li>▪ 1 full-height riser with three PCI Express 2.0 x8 wired slots (one x16 connector and two x8 connectors)</li> <li>▪ 2 Redundant high-efficient 760W power supply</li> <li>▪ 2 SATA cables for internal 2.5" HDD bays</li> <li>▪ 1 cable for Optical drive bay</li> <li>▪ 1 AXXROMBSASMR (Manta Ray) to backplane</li> </ul>	1

Image	Product Code MM UPC	Description	Minimum Order Quantity
		RAID cable <ul style="list-style-type: none"> <li>▪ 2 processor heatsinks</li> <li>▪ 2 chassis front handles in the box (ears)</li> </ul>	
	SR2612URRNA 905746 00735858214544	Same as Intel® Server System SR2612UR. Includes: North American power cord.	1

### 1.3 I/O Modules







Image	Product Code MM UPC	Description	Minimum Order Quantity
	<p>AXX10GBIOMOD 900962 735858206525</p>	<p>10GbE I/O module Dual port CX4 connector, based on Intel 82598 EB controller. Compatible with S5520UR and S5500WB boards only.</p>	<p>1</p>
	<p>AXX4GBIOMOD2 901359 735858206532</p>	<p>Quad port GbE I/O module, based on Intel 82576 controller. RJ-45 connectors. Compatible with S5520UR and S5500WB boards only.</p>	<p>1</p>
	<p>AXXIBQDRIOMOD 902559 735858212601</p>	<p>Single port QDR speed InfiniBand I/O Module. CX4 powered connector. MT25408A0-FCC-QIS Controller. Compatible with S5520UR boards only</p>	<p>1</p>
	<p>AXX4SASMOD 900946 00735858206372</p>	<p>Internal 4-port SAS module, based on LSI* 1064e controller, with Embedded RAID support.(primarily targeted at non-Intel chassis) Compatible with S5520UR, S5500WB, S5520HC, S5520SC, SR2612UR and SR1690WB. Not compatible with SR1600UR, SR1625UR, SR2600UR and SR2625UR due to mechanical limitations.</p>	<p>1</p>

Image	Product Code MM UPC	Description	Minimum Order Quantity
	AXXROMBSASMR 901641 735858208017	Internal 4-port SAS module, based on LSI* 1078e controller. Provides 4 port full featured SAS/SATA RAID 0,1, 5, 6 and striping capability for spans 10, 50, 60.(primarily targeted at non-Intel chassis). Supports the RAID Smart Battery (AXXRSBBU3). Compatible with S5520UR, S5500WB, S5520HC, S5520SC, SR2612UR and SR1690WB. Not compatible with SR1600UR, SR1625UR, SR2600UR and SR2625UR due to mechanical limitations.	5
	AXXRMS2AF080 907853 00735858215732	Intel® Integrated RAID Module SRMS2AF080 provides 8 port entry-level SAS-2/6Gbps RAID 0,1,5 and striping capability for spans 10, 50. Includes cables. No BBU option.	5
	AXXRMS2AF040 907854 00735858215756	Intel® Integrated RAID Module SRMS2AF040 provides 4 port entry-level SAS-2/6Gbps RAID 0,1,5 and striping capability for spans 10, 50. Includes cables. No BBU option.	5
	AXXRMS2LL080 907855 00735858215749	Intel® Integrated RAID Module SRMS2LL080 provides 8 port basic RAID 0/1/1E and JBOD mode. Includes cables. No BBU option.	5
	AXXRMS2LL040 907856 00735858215763	Intel® Integrated RAID Module SRMS2LL040 provides 4 port basic RAID 0/1/1E and JBOD mode. Includes cables. No BBU option	5

Image	Product Code MM UPC	Description	Minimum Order Quantity
	AXXGBIOMOD 880518 735858184779	Dual Port Gigabit Ethernet I/O Expansion Module. Based on Intel 82571EB GbE controller. Compatible with Intel Server Boards S5520UR, S5500WB, S5000PALR and S5400SF.	1
	AXXSASIOMOD 902300 735858184786	External 4 port SAS I/O Expansion Module. Based on LSI 1068 controller. Compatible with Intel Server Boards S5520UR, S5500WB, S5000PALR and S5400SF.	1
	AXXIBIOMOD 881891 735858185219	InfiniBand I/O Expansion Module, SDR speed. Compatible with Intel Server Boards S5520UR, S5000PALR and S5400SF.	1

## 1.4 System Spares and Accessories







Image	Product Code MM UPC	Description	Minimum Order Quantity
	AXXRMM3 900961 735858206570	Remote management module 3 kit (includes module, standard and Intel chassis specific mounting brackets, long and short cables)	1
	ASR2612SASCBL 905181 735858213882	Intel® Server System SR2612UR Mini SAS cable accessory for use with Intel RAID cards with 8087 connector.	1
	AXXSATADVROM 906872 735858197663	Slimline SATA DVDROM Device	1



Image	Product Code MM UPC	Description	Minimum Order Quantity
	AXXSATADVDRWROM 898292 735858197670	Slim SATA DVD+/-RW ROM Accessory	1
	FPWRCABLENA 879287 735858181129	North American Power Cord Spare	1
	FSR2612FAN 903787 735858212021	SR2612UR Fan spare kit.	1



## 1.5 Bezel

Image	Product Code MM UPC	Description	Minimum Order Quantity
	ASR2612BEZEL 909828 735858218665	SR2612UR Black Bezel	5

## 1.6 Power Sub-system Spares

Image	Product Code MM UPC	Description	Minimum Order Quantity
	FSR2612PS 903891 735858212038	SR2612UR 760W Hot-Swap power supply module	1

## 1.7 Riser Spares and Accessories

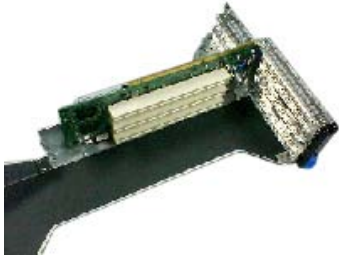
Image	Product Code MM UPC	Description	Minimum Order Quantity
	ASR26XXFHLPR 901077 735858206471	5 slot PCI-e active Riser. Bridges are placed on riser to multiply provided 24 PCI Express 2.0 lanes into 40 for on-the-fly load balance. Riser provides: 1 full-size x16 physical x8 electrical slots 2 full-size x8 physical x8 electrical slot 2 low-profile x8 physical x8 electrical slots.	5
	ASR26XXFHR 901079 735858206488	3 slot passive PCI-e Riser. Provides: 1 full-size x16 physical x8 electrical slot 2 full-size x8 physical x8 electrical slots	5
	ASR26XXFHXR 901080 735858206495	5 slot PCI-e / PCI-X active riser. PCIe to PCI-X bridge is placed on riser. Riser Provides: 2 Full-size PCI-X 133 slots 1 full-size x8 physical x8 electrical slot 2 low-profile x8 physical x8 electrical slots	5
	ASR26XXFH3XR 902279 735858208437	3 slot PCI-X riser assembly. Comes with modified bracket for SR2600/2625. Note: The riser need to be disassembled from the bracket before installing it on Intel® Server System SR2612UR.	1

## 1.8 Intel® RAID Controller Options:





Image	Product Code MM UPC	Description	Minimum Order Quantity
	<p>SRCSASJV 892602 00735858196444</p>	<p>Intel® RAID Controller SRCSASJV - PCIe x8, 8P SAS RAID Controller with Mux (ports can be configured as internal or external), ships with 512MB DIMM, and supports up to 1 GB DDR2 DIMM.</p> <p><b>Note:</b> SRCSASJV supports either the RAID Smart Battery (AXXRSBBU3) or RAID Portable Cache Module (AXXRPCM3). Using both the AXXRSBBU3 and AXXRPCM3 is not supported. Cable accessory ASR2612SASCBL is required for this controller.</p>	5
	<p>SRCSASLS4I 896952 00735858201353</p>	<p>Intel® RAID Controller SRCSASLS4I - PCIe x8, 4P SAS RAID Controller, 128MB embedded memory, MD2 Low Profile, half length form factor. Supports the RAID Smart Battery (AXXRSBBU6).</p> <p><b>Note:</b> Cable accessory ASR2612SASCBL is required for this controller.</p>	5
	<p>SASWT4I 900267 00735858205108</p>	<p>Intel® RAID Controller SASWT4I - PCIe x4, 4P SAS Controller with entry-level HW RAID 0/1/1E/10E, low profile, half-length MD2 compliant form factor. No BBU option.</p>	5
	<p>RS2BL040 903494 00735858211239</p>	<p>Intel® RAID Controller RS2BL040 - 6Gb/s SAS, 3Gb/S SAS/SATA, x8 PCIe 2.0, 4 internal ports, 512MB embedded memory, MD2 Low Profile, half length form factor. Supports the RAID Smart Battery (AXXRSBBU7 or AXXRSBBU8).</p> <p><b>Note:</b> Cable accessory ASR2612SASCBL is required for this controller.</p>	5
	<p>RS2BL080 903493 00735858210140</p>	<p>Intel® RAID Controller RS2BL080 - 6Gb/s SAS, 3Gb/S SAS/SATA, x8 PCIe 2.0, 8 internal ports, 512MB embedded memory, MD2 Low Profile, half length form factor. Supports the RAID Smart Battery (AXXRSBBU7 or AXXRSBBU8).</p> <p><b>Note:</b> Cable accessory ASR2612SASCBL is required for this controller.</p>	5











Image	Product Code MM UPC	Description	Minimum Order Quantity
	RS2BL080DE 903497 00735858211246	Intel® RAID Controller RS2BL080 "DE" (RS2BL080 supporting Disk Encryption) - 6Gb/s SAS, 3Gb/S SAS/SATA, x8 PCIe 2.0, 8 internal ports, 512MB embedded memory, MD2 Low Profile, half length form factor. Provides key and management for Self-Encrypting Disks. Supports the RAID Smart Battery (AXXRSBBU7 or AXXRSBBU8). <b>Note:</b> Cable accessory ASR2612SASCBL is required for this controller.	5
	RS2BL080SNGL 907739 00735858214742	Intel® RAID Controller RS2BL080 - 6Gb/s SAS, 3Gb/S SAS/SATA, x8 PCIe 2.0, 8 internal ports, 512MB embedded memory, MD2 Low Profile, half length form factor. Supports the RAID Smart Battery (AXXRSBBU7 or AXXRSBBU8). <b>Note:</b> Cable accessory ASR2612SASCBL is required for this controller.	1
	RS2MB044 904993 00735858213028	Intel® RAID Controller RS2MB044 - PCIe x8, Mainstream 6G SAS RAID controller with 4 internal and 4 external ports for SAS/SATA drives. Supports the RAID Smart Battery (AXXRSBBU7 or AXXRSBBU8). <b>Note:</b> Cable accessory ASR2612SASCBL is required for this controller.	5
	RS2PI008 903492 00735858211222	Intel® RAID Controller RS2PI008 - 6Gb/s SAS, 3Gb/S SAS/SATA, x8 PCIe 2.0, 8 external ports, 512MB embedded memory, MD2 Low Profile, half length form factor. Supports the RAID Smart Battery (AXXRSBBU7 or AXXRSBBU8).	5
	RS2PI008DE 904919 00735858212878	Intel® RAID Controller RS2PI008"DE" (RS2PI008 supporting Disk Encryption) - 6Gb/s SAS, 3Gb/S SAS/SATA, x8 PCIe 2.0, 8 external ports, 512MB embedded memory, MD2 Low Profile, half length form factor. Supports the RAID Smart Battery (AXXRSBBU7 or AXXRSBBU8).	5
	AXXRSBBU3 900954 735858181853	Intel® RAID Smart Battery Backup module for use with Intel® Integrated Server RAID	5

Image	Product Code MM UPC	Description	Minimum Order Quantity
	<p>AXXRSBBU6 897528 00735858201872</p>	<p>Intel® RAID Smart Battery Backup module for use with Intel® Integrated Server RAID</p>	<p>5</p>
	<p>AXXRSBBU7 903148 00735858210676</p>	<p>Intel® RAID Smart Battery Backup module for use with Intel® Integrated Server RAID</p>	<p>5</p>
	<p>AXXRSBBU8 909893 00735858217620</p>	<p>Intel® RAID Smart Battery Backup module for use with Intel® Integrated Server RAID</p>	<p>5</p>
	<p>AXXRPCM3 891156 00735858197854</p>	<p>Intel® Portable Cache Module AXXRPCM3 for use with SRCASJV – Combines 256 MB DDR2 memory DIMM and battery; up to 72 hours retention.</p>	<p>5</p>

## 1.9 Product Descriptions - Overview

VMware vSphere\* software is now available when ordering an Intel® Server Board or Intel® Server System. **Customers can only order these SKUs at the time they are ordering an Intel® Server Board or Intel® Server System.** These SKUs cannot be ordered individually. The number of VMware vSphere SKU purchase has to coincide with number of system or boards purchased. Example: Order 10 boards – you can order 10 VMware SKUs. Customers will need to join VMware System Builder Program to get sales support from VMware. For support information please visit: <http://www.vmware.com/partners/partners.html>.

### 1.10 VMware vSphere\* and vCenter\* Server SKUs

The following VMware vSphere SKUs are offered when purchasing a qualifying Intel® Server Board or Intel® Server System. Each SKU contains a software product activation code for user to enter to download software and install. As directed on the certificate, the end user must register the product activation code with VMware at <http://www.vmware.com/code/intel> within 30 days to access VMware Software, Support and Subscription Services.

VMware vSphere\* and vCenter\* Server SKUs:

- Essentials - This license activation code gives the user VMware vSphere\* 4 Essentials Bundle for 3 hosts (Max two processors per host and six cores per processor), with one year VMware subscription.
- Essentials Plus - This license activation code gives the user VMware vSphere\* 4 Essentials Plus Bundle for 3 hosts (maximum two processors per host and six cores per processor), with one year VMware Gold support and subscription.
- Standard - This license activation code gives the user VMware vSphere\* 4 Standard for one processor (maximum six cores per CPU), with one year VMware Gold support and subscription.
- Advanced - This license activation code gives the user VMware vSphere\* 4 Advanced for 1 Processor (maximum 12 cores per CPU), with one year VMware Gold support and subscription.
- Enterprise Plus - This license activation code gives the user VMware vSphere\* 4 Enterprise Plus for 1 Processor (maximum 12 cores per CPU), with one year VMware Gold support and subscription.
- VMware vCenter\* Server Standard for vSphere\* - This license activation code gives the user VMware vCenter\* Server 4 Standard for vSphere\* (includes Orchestrator and Linked Mode), with one year VMware Gold support and subscription.

**VMware vSphere\* and VMware vCenter\* Standard – Order Codes:**

<b>Product Code</b>	<b>UPC</b>	<b>MM</b>	<b>Description</b>	<b>MOQ</b>
VMW4ESS	7 35858 21272 4	904791	Software license activation code certificate for VMware vSphere* 4 Essentials Bundle for 3 hosts (Max 2 CPUs per host and 6 cores per CPU) with 1 year VMware Subscription.	1
VMW4ESSPLUS	7 35858 21273 1	904792	Software license activation code certificate for VMware vSphere* 4 Essentials Plus Bundle for 3 hosts (Max 2 CPUs per host and 6 cores per CPU) with 1 year VMware Gold Support and Subscription.	1
VMW4STD	7 35858 21274 8	904793	Software license activation code certificate for VMware vSphere* 4 Standard for 1 Processor (Max 6 cores per CPU) with 1 year VMware Gold Support and Subscription.	1
VMW4ADV	7 35858 21275 5	904797	Software license activation code certificate for VMware vSphere* 4 Advanced for 1 Processor (Max 12 cores per CPU) with 1 year VMware Gold Support and Subscription.	1
VMW4ENTPLUS	7 35858 21276 2	904800	Software license activation code certificate for VMware vSphere* 4 Enterprise Plus for 1 Processor (Max 12 cores per CPU) with 1 year VMware Gold Support and Subscription.	1
VMWVCSTD	7 35858 21277 9	904801	Software license activation code certificate for VMware vCenter* Server 4 Standard (includes Orchestrator and Linked Mode) with 1 year VMware Gold Support and Subscription.	1