

Intel® Server System SR1630BC

Technical Product Specification

Intel order number E44588-001

Revision 1.0

January 2009

Enterprise Platforms and Services Division - Marketing

Revision History

Date	Revision Number	Modifications
January 2009	1.0	Initial Release

Disclaimers

Information in this document is provided in connection with Intel® products. No license, express or implied, by estoppel or otherwise, to any intellectual property rights is granted by this document. Except as provided in Intel's Terms and Conditions of Sale for such products, Intel assumes no liability whatsoever, and Intel disclaims any express or implied warranty, relating to sale and/or use of Intel products including liability or warranties relating to fitness for a particular purpose, merchantability, or infringement of any patent, copyright or other intellectual property right. Intel products are not intended for use in medical, life saving, or life sustaining applications. Intel may make changes to specifications and product descriptions at any time, without notice.

Designers must not rely on the absence or characteristics of any features or instructions marked "reserved" or "undefined." Intel reserves these for future definition and shall have no responsibility whatsoever for conflicts or incompatibilities arising from future changes to them.

This document contains information on products in the design phase of development. Do not finalize a design with this information. Revised information will be published when the product is available. Verify with your local sales office that you have the latest datasheet before finalizing a design.

The server boards / systems referenced in this document may contain design defects or errors known as errata which may cause the product to deviate from published specifications. Current characterized errata are available on request.

Intel, Pentium, Itanium, and Xeon are trademarks or registered trademarks of Intel Corporation.

*Other brands and names may be claimed as the property of others.

Copyright © Intel Corporation 2009. All rights reserved.

Table of Contents

1. Introduction.....	5
1.1 Chapter Outline	5
1.2 Server Board Use Disclaimer	5
2. Product Overview.....	6
2.1 System Views	9
2.2 System Dimensions	9
2.3 System Components.....	10
2.4 System Boards	11
2.5 Hard Drive and Peripheral Bays.....	11
2.6 Rack and Cabinet Mounting Options	12
3. Power Sub-System	13
3.1 Mechanical Overview	14
3.2 Output Connectors	16
3.2.1 P1 - Main Power Connector	16
3.2.2 P2 - Processor/DDR3 Power Connector	16
3.2.3 P3 - Power Signal Connector	17
3.2.4 P4 and P5 - SATA Hard Drive Power Connectors.....	17
3.2.5 P6 - Slim-line SATA Optical Disk Drive Power Connector	18
3.3 Efficiency	18
3.4 AC Input Voltage Requirement.....	18
3.5 Protection Circuits	19
3.5.1 Over-current Protection (OCP)	19
3.5.2 Over-voltage Protection (OVP).....	19
3.5.3 Over-temperature Protection (OTP).....	20
3.6 AC Power Cord Specification Requirements.....	20
4. Cooling Sub-System	21
4.1.1 System Fan Connectors	22
4.2 Power Supply Fans.....	23
4.3 Processor Air Duct and Air Baffle	23
5. Peripheral and Hard Drive Support.....	24

5.1	Optical Drive Support.....	25
5.1.1	Optical Drive Support.....	25
5.2	Hard Disk Drive Support	25
6.	Front Control Panel.....	26
6.1.1	Power / Sleep LED	27
6.1.2	System Status LED	27
6.1.3	Drive Activity LED	28
7.	PCI Riser Cards and Assembly	29
8.	Supported Intel® Server Boards	30
8.1	Intel® Server Board S5500BC Feature Set	30
9.	Environmental and Regulatory Specifications.....	32
9.1	System Level Environmental Limits.....	32
9.2	Serviceability and Availability.....	32
9.3	Replacing the CMOS Battery	33
9.4	Product Regulatory Compliance	34
9.5	Use of Specified Regulated Components	34
9.6	Electromagnetic Compatibility Notices	37
9.6.1	USA	37
9.6.2	FCC Verification Statement.....	38
9.6.3	ICES-003 (Canada).....	38
9.6.4	Europe (CE Declaration of Conformity)	38
9.6.5	Japan EMC Compatibility.....	38
9.6.6	BSMI (Taiwan)	39
9.6.7	RRL (Korea).....	39
9.6.8	CNCA (CCC-China)	39
9.7	Product Ecology Compliance	39
9.8	Other Markings.....	42
	Appendix A: Integration and Usage Tips	44
	Appendix B: POST Code Diagnostic LED Decoder	45
	Appendix C: POST Error Messages and Handling	49
	Glossary	53
	Reference Documents	54

List of Figures

Figure 1. Intel® Server System SR1630BC..... 9

Figure 2. Major System Components – Intel® Server System SR1630BC 10

Figure 3. Back Panel Features 11

Figure 4. Drive Bays – Intel® Server System SR1630BC 12

Figure 5. Power Supply Mechanical Drawing 15

Figure 6. AC Power Cord Drawing..... 20

Figure 7. Fan Module Assembly – Intel® Server System SR1630BC 21

Figure 8. Air Duct for the Intel® Server System SR1630BC..... 23

Figure 9. Peripheral Location..... 24

Figure 10. Front Control Panel – Intel® Server System SR1630BC..... 26

Figure 11. PCI Riser Card Assembly 29

Figure 12. Diagnostic LED Placement Diagram 45

List of Tables

Table 1. System feature set.....	6
Table 2. Intel® Server System SR1630BC Dimensions	9
Table 3. Cable Harness Definition	16
Table 4. P1 – Main Power Connector Pin-out.....	16
Table 5. P2 – Processor/DDR3 Power Connector Pin-out	17
Table 6. P3 –Power Signal Connector Pin-out.....	17
Table 7. P4 and P5 – SATA Hard Drive Power Connector Pin-out.....	17
Table 8. P6 – Slim-line SATA Optical Disk Drive Power Connector Pin-out.....	18
Table 9. Power Supply Efficiency	18
Table 10. AC Input Rating.....	18
Table 11. Over-current Protection (OCP)	19
Table 12. Over-Voltage Protection (OVP) Limits	19
Table 13. Cooling Zones.....	22
Table 14. System Fan Connector Pin-outs	22
Table 15. Control Panel LED Functions.....	26
Table 16. SSI Power LED Operation	27
Table 17. Control Panel LED Operation	27
Table 18. System Environmental Limits Summary	32
Table 19. Product Safety & Electromagnetic (EMC) Compliance	35
Table 20. POST Progress Code LED Example	45
Table 21. Diagnostic LED POST Code Decoder	46
Table 22. POST Error Messages and Handling.....	49
Table 23. POST Error Beep Codes	52

1. Introduction

This Technical Product Specification (TPS) provides system specific information detailing the features, functionality, and high level architecture of the Intel® Server System SR1630BC. You should also reference the Intel® Server Board S5500BC Technical Product Specification to obtain greater detail of functionality and architecture specific to the integrated server board, but what is also supported on this server system.

In addition, you can obtain design level information for specific sub-systems by ordering the External Product Specifications (EPS) or External Design Specifications (EDS) for a given subsystem. EPS and EDS documents are not publicly available. They are only made available under NDA with Intel and must be ordered through your local Intel representative. See the *Reference Documents* section at the end of this document for a complete list of available documents.

The Intel® Server System SR1630BC may contain design defects or errors known as errata which may cause the product to deviate from published specifications. Refer to the *Intel® Server Board S5500BC/ Intel® Server System SR1630BC Specification Update* for published errata.

1.1 Chapter Outline

This document is divided into the following chapters:

- Chapter 1 – Introduction
- Chapter 2 – Product Overview
- Chapter 3 – Power Sub-System
- Chapter 4 – Cooling Sub-System
- Chapter 5 – Peripheral and Drive Support
- Chapter 6 – Front Control Panel
- Chapter 7 – PCI Riser Card and Assembly
- Chapter 8 – Supported Intel Server Board
- Chapter 9 – Environmental and Regulatory Specifications
- Appendix A – Integration and Usage Tips
- Appendix B – POST Code Diagnostic LED Decoder
- Appendix C – Post Error Message and Handling
- Glossary
- Reference Documents

1.2 Server Board Use Disclaimer

Intel Corporation server boards support add-in peripherals and contain a number of high-density VLSI and power delivery components that need adequate airflow to cool. Intel ensures through its own chassis development and testing that when Intel server building blocks are used together, the fully integrated system will meet the intended thermal requirements of these components. It is the responsibility of the system integrator who chooses not to use Intel developed server building blocks to consult vendor datasheets and operating parameters to determine the amount of air flow required for their specific application and environmental conditions. Intel Corporation cannot be held responsible if components fail or the server board does not operate correctly when used outside any of their published operating or non-operating

limits.

2. Product Overview

The Intel® Server System SR1630BC is a 1U server system designed to support the Intel® Server Board S5500BC. The server board and the system have features designed to support the high-density server market. This chapter provides a high-level overview of the system features. Greater detail for each major system component or feature is provided in the following chapters.

Table 1. System feature set

Feature	Description
Server Board	Intel® Server Board S5500BC
Processor	Support for one or two Intel® Xeon® Processor 5500 series in FC-LGA 1366 Socket B package with up to 95 W Thermal Design Power (TDP) <ul style="list-style-type: none"> • 4.8 GT/s, 5.86 GT/s and 6.4 GT/s Intel® QuickPath Interconnect (Intel® QPI) • EVRD11.1 For a complete list of supported processors, see: http://support.intel.com/support/motherboards/server/s5500bc/compat.htm
Memory	<ul style="list-style-type: none"> • Eight DIMMs across four memory channels (two channels per processor) • Support for 800/1066/1333 MT/s ECC Registered DIMM and ECC or Non-ECC unbuffered DIMM DDR3 memory
Chipset	<ul style="list-style-type: none"> • Intel® 5500 Chipset I/O Hub • Intel® 82801Jx I/O Controller Hub

Feature	Description
Peripheral Interfaces	<p>External connections:</p> <ul style="list-style-type: none"> • DB-15 video connector (back) • RJ-45 serial Port A connector • Two RJ-45 10/100/1000 Mb network connections • Four USB 2.0 connectors (back) • One USB 2.0 connector (front) <p>Internal connections:</p> <ul style="list-style-type: none"> • Two USB 2x5 pin header, each supports two USB 2.0 ports • One DH-10 Serial Port B header • Six Serial ATA (SATA) II connectors • One SSI-EEB compliant front panel header • One SSI-EEB compliant 24-pin main power connector • One SSI-compliant 8-pin CPU power connector • One SSI-compliant 5-pin auxiliary power connector • One 4-Pin SGPIO connector
Video	<p>On-board ServerEngines* LLC Pilot II BMC controller</p> <ul style="list-style-type: none"> • Integrated 2D video controller • 32 MB DDR2 667 MHz Memory
LAN	<p>Two 10/100/1000 NICs</p> <ul style="list-style-type: none"> ▪ One 82574L GbE PCI Express* Network Controller connects to the Gen2 x1 interface on the Intel® 5500 IOH chipset. ▪ One 82567 Gigabit Network Connection that connects to the Gigabit LAN Connect Interface / LAN Connect Interface on the Intel® ICH10R ▪ Two 10/100/1000 Base-TX Interfaces through RJ-45 connectors with integrated magnetics. ▪ Link and Speed LEDs on the RJ-45 Connector.
Expansion Capabilities	<p>One x8 PCI Express* Gen 2 PCI riser slot capable of supporting a low-profile PCI Express* add-in card which consumes power less than 15W</p>
Hard Drive Options	<p>Fixed mount hard driver system: two SATA drives</p>
Peripherals	<ul style="list-style-type: none"> • Slimline bay for slimline SATA optical drive • One PCI Express* x8 Add-in Card slot (Gen 2)
Control Panel	<ul style="list-style-type: none"> • Standard control panel

Feature	Description
LEDs and displays	LEDs with standard control panel: <ul style="list-style-type: none"> ▪ NIC1 Activity ▪ NIC2 Activity ▪ Power / Sleep ▪ System Status ▪ Hard Drive Activity Intel® Light-Guided diagnostic LEDs: <ul style="list-style-type: none"> ▪ Fan Fault ▪ DIMM Fault ▪ CPU Fault ▪ 5V-STBY ▪ System Stat ▪ POST Code Diagnostics
Power Supply	Single 400-W power supply
Fans	Two 97 x 94 x 33mm, non-redundant, variable-speed system blower fans Two non-redundant 40 mm power supply internal fans
Server Management	On-board ServerEngines* LLC Pilot II Controller <ul style="list-style-type: none"> ▪ Integrated Baseboard Management Controller (Integrated BMC),. IPMI 2.0 compliant ▪ Integrated Super I/O on LPC interface Support for Intel® Server Management Software 3.5
System Management	Intel® System Management Software

2.1 System Views

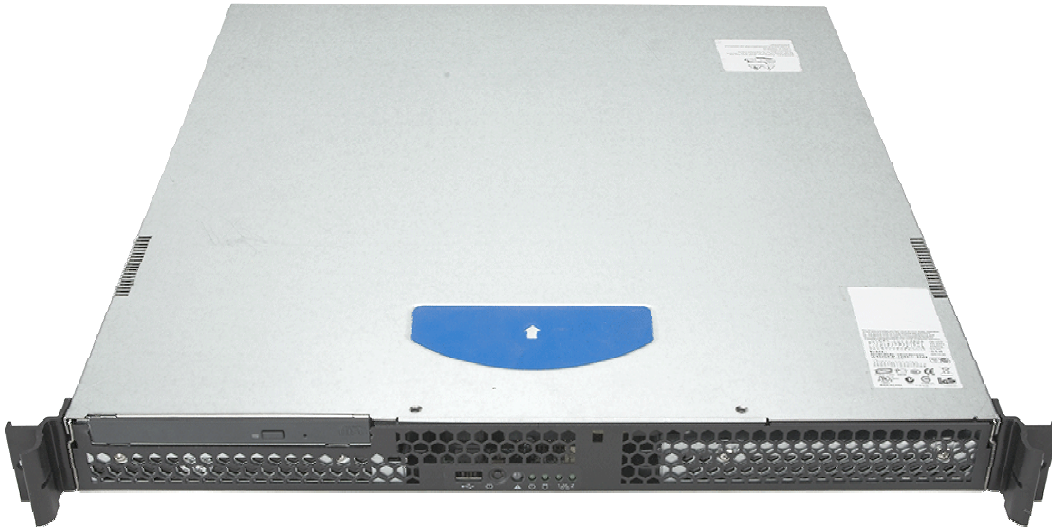

Figure 1. Intel® Server System SR1630BC

2.2 System Dimensions

Table 2. Intel® Server System SR1630BC Dimensions

Height	1.7 inches
Width without rails	16.9 inches
Depth without CMA	20 inches
Maximum weight	22 pounds

2.3 System Components

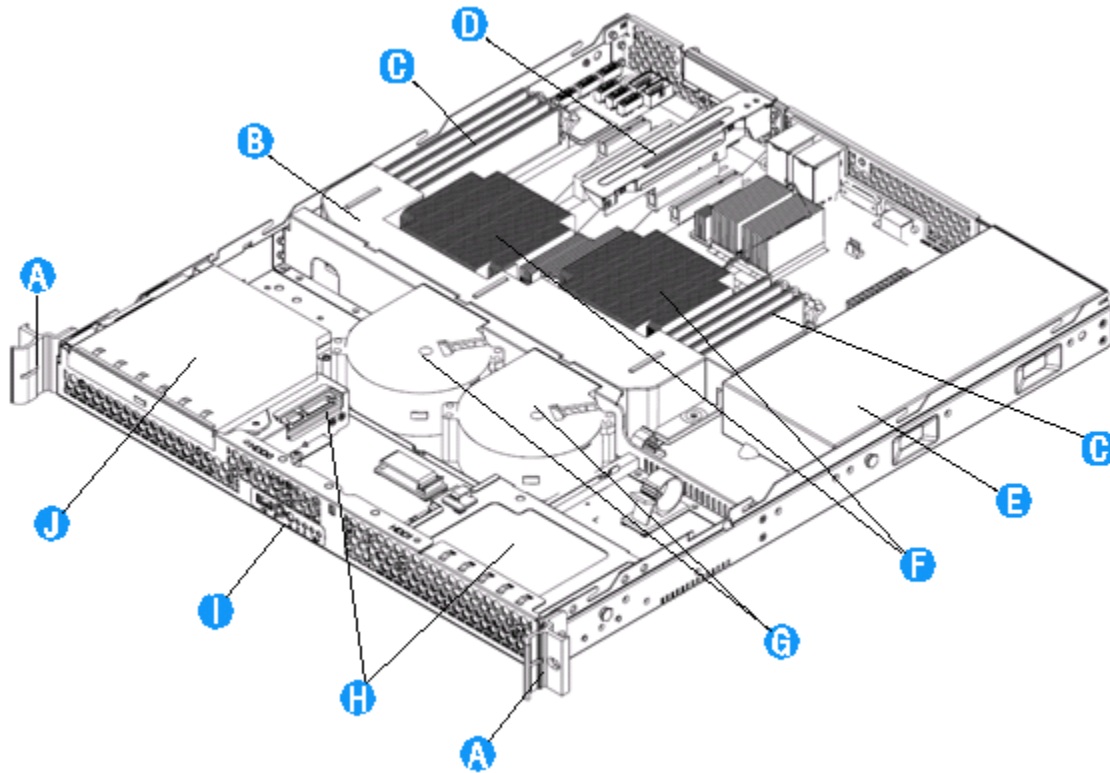

A	Rack handles (two)	F	CPU Heat sink (two)
B	Processor air duct	G	System blower fans (two)
C	System memory DIMM sockets	H	Hard drives (two)
D	PCI add-in card bracket	I	Control panel
E	Power supply	J	Slimline optical drive

Figure 2. Major System Components – Intel® Server System SR1630BC

Note: The I/O connector locations on the back of the chassis are pre-cut, making an I/O shield unnecessary. You must install the supplied EMI gasket to maintain electromagnetic interference (EMI) compliance levels.

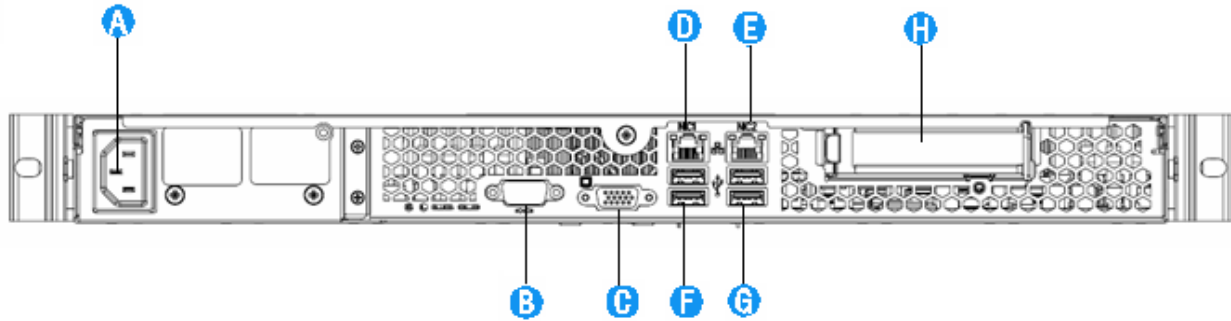

A	AC Power Connector	E	NIC 2 Connector (10 / 100 / 1000 Mb) BMC Management Port
B	Serial Port A	F	USB Ports 6 and 7
C	Video Connector	G	USB Ports 8 and 9
D	NIC 1 Connector (10 / 100 / 1000 Mb)	H	PCI Express* Slot

Figure 3. Back Panel Features

2.4 System Boards

The system includes system boards used as internal interconnect and provide feature accessibility. The following provides a brief description.

Riser card – The system supports one PCI riser card that supports one low-profile PCI Express* x8 add-in card which consumes power less than 15 W.

2.5 Hard Drive and Peripheral Bays

The Intel® Server System SR1630BC is designed to support up to two fixed 3.5-inch Serial ATA (SATA) hard drives and one slimline optical device.

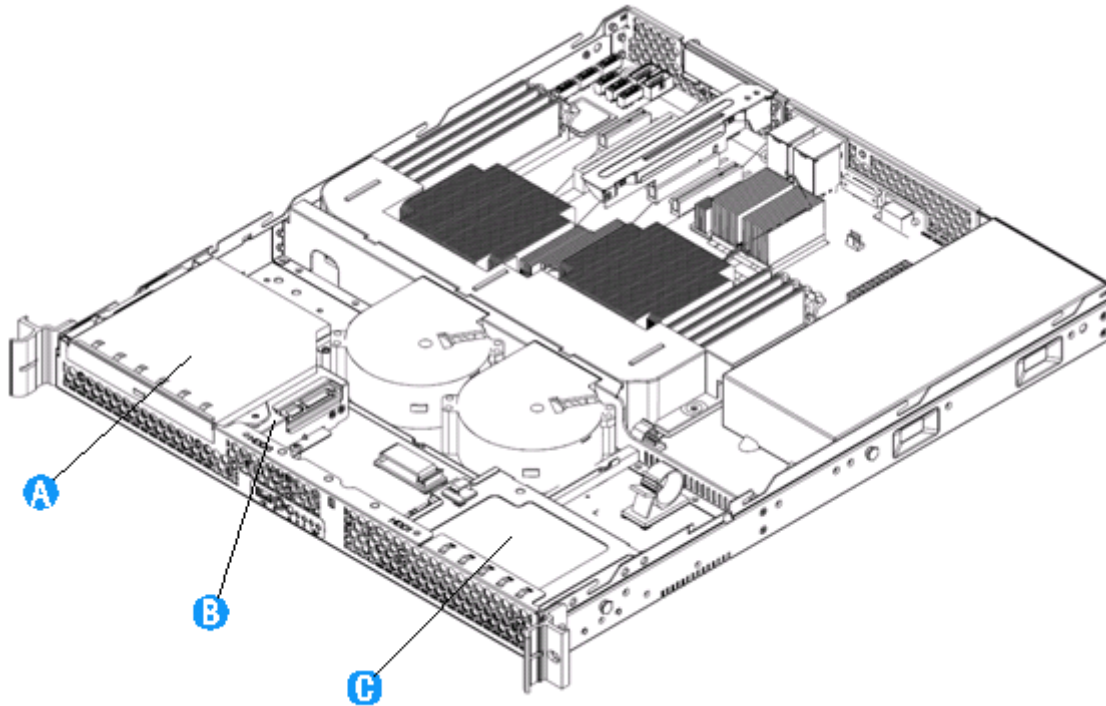

A	Slimline optical drive bay
B	Hard drive bay HDD0 (located under the slimline optical drive bay)
C	Hard drive bay HDD1

Figure 4. Drive Bays – Intel® Server System SR1630BC

2.6 Rack and Cabinet Mounting Options

You can install the Intel® Server System SR1630BC in 19-inch wide by up to 30-inch deep server cabinets. The system supports three rack mount options:

- A fixed mount relay rack / cabinet mount kit which can be configured to mount the system into either a 2-post or 4-post rack cabinet. (Product order code for the cabinet mount kit: AXXBRACKETS.)
- A tool-less full extracting slide rail kit designed to support an optional cable management arm. (Product order code for the sliding rail kit: AXXHERAIL. Product order code for the cable management arm: AXXRACKCARM.)
- A basic slide rail kit designed to mount the chassis into a standard 19-inch by up to 30-inch deep EIA-310D compatible server cabinet. (Product order code for the slide rail kit: AXXBASICRAIL.)

3. Power Sub-System

The power sub-system consists of one, non-redundant 400-W power supply that supports a 1U rack mount server system. The power supply and the power supply sub-system will have six outputs: 3.3 V, 5 V, 12 V1, 12V2, -12 V, and 5 VSB. The input is auto-ranging and power factor corrected. The form factor is EPS1U at 240 mm depth and wire harness output. It provides integrated management features, including over-temperature protection circuitry and over-voltage protection circuitry.

The power supply provides two non-redundant 40 mm fans for self-cooling.

3.1 Mechanical Overview

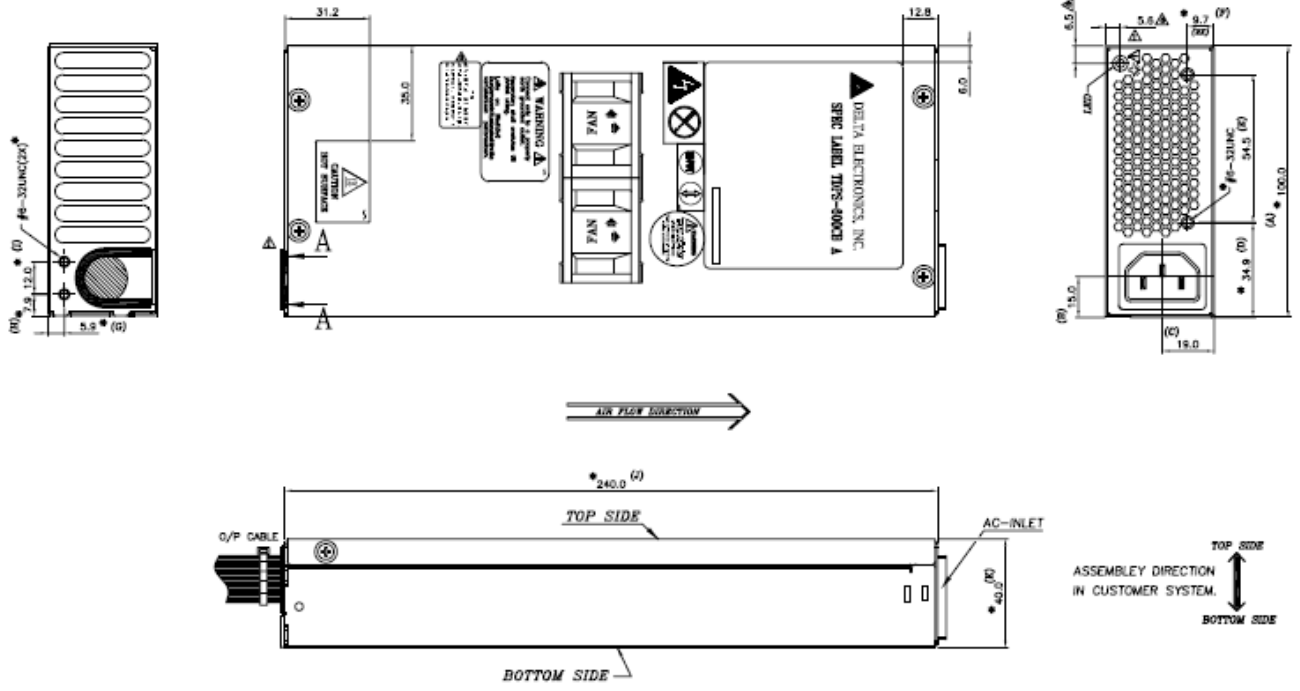

3.2 Output Connectors

The power supply has a cable harness with five power connectors used to power various platform sub-systems. The following table defines each power connector.

Table 3. Cable Harness Definition

Label	Length (mm)	Description
P1	350	Main Power Connector
P2	300	Processor/DDR3 Power Connector
P3	330	Power Signal Connector
P4	350	P4 SATA drive power connector
P5	145	P5 SATA drive power connector
P6	200	Slim SATA DVD power connector

3.2.1 P1 – Main Power Connector

Connector housing: 24-pin Molex* Mini-Fit Jr. 39-01-2245 (94V2) or equivalent

Contact: Molex* Mini-Fit Jr, Crimp 5558 or equivalent

Table 4. P1 – Main Power Connector Pin-out

Pin	Signal	18 Awg Color	Pin	Signal	18 Awg Color
1	+3.3 VDC	Orange	13	+3.3 VDC	Orange
2	+3.3 VDC	Orange	14	-12 VDC	Blue
3	COM	Black	15	COM	Black
4	+5 VDC ¹	Red	16	PSO#	Green
5	COM	Black	17	COM	Black
6	+5 VDC	Red	18	COM	Black
7	COM	Black	19	COM	Black
8	PWR OK	Gray	20	Reserved	N.C.
9	5 VSB	Purple	21	+5 VDC	Red
10	+12 V	Yellow/Black	22	+5 VDC	Red
11	+12 V	Yellow/Black	23	+5 VDC	Red
12	+3.3 VDC	Orange	24	COM	Black

Notes:

1. 5V Remote Sense double-crimped into pin 4.

3.2.2 P2 – Processor/DDR3 Power Connector

Connector housing: 8-pin Molex* 39-01-2085 (94V2) or equivalent

Contact: Molex*, Mini-Fit Jr, HCS, 44476-1111 or equivalent

Table 5. P2 – Processor/DDR3 Power Connector Pin-out

Pin	Signal	18 Awg Color	Pin	Signal	18 Awg Color
1	COM	Black	5	+12V1	Yellow
2	COM	Black	6	+12V1	Yellow
3	COM	Black	7	+12V1	Yellow
4	COM	Black	8	+12V1	Yellow

3.2.3 P3 – Power Signal Connector

Connector housing: 5-pin Molex* 50-57-9705 (94V2) or equivalent

Contacts: Molex* 16-02-0087 or equivalent

Table 6. P3 –Power Signal Connector Pin-out

Pin	Signal	24 Awg Color
1	I ² C Clock	White/Green Stripe
2	I ² C Data	White/Yellow Stripe
3	Reserved	NC
4	COM	Black
5	3.3RS	White/Brown Stripe

3.2.4 P4 and P5 – SATA Hard Drive Power Connectors

Connector housing: JWT* A3811H00-5P (94V2) or equivalent

Contact: JWT* A3811TOP-0D or equivalent

Table 7. P4 and P5 – SATA Hard Drive Power Connector Pin-out

Pin	Signal	18 Awg Color
1	+3.3 V	Orange
2	COM	Black
3	+5VDC	Red
4	COM	Black
5	+12 V	Yellow/Black

3.2.5 P6 – Slim-line SATA Optical Disk Drive Power Connector

Connector housing: 6-pin SSATA Pwr

Contact: 15u" plating minimum

Table 8. P6 – Slim-line SATA Optical Disk Drive Power Connector Pin-out

Pin	Signal	22 AWG Color
1	Reserved	N.C.
2	+5 VDC	Red
3	+5 VDC	Red
4	Reserved	N.C.
5	COM	Black
6	COM	Black

3.3 Efficiency

The following table provides the required minimum efficiency level at various loading conditions. These are provided at three different load levels; 100%, 50% and 20%. Output should be loaded according to the proportional loading method defined by 80 Plus. Efficiency should be tested per 80 Plus requirement.

Table 9. Power Supply Efficiency

Loading	100% of Maximum	50% of Maximum	20% of Maximum
Minimum Efficiency	82%	85%	82%

3.4 AC Input Voltage Requirement

The power supply must operate within all specified limits over the following input voltage range, shown in the following table. Harmonic distortion of up to 10% THD must not cause the power supply to go out of specified limits. The power supply shall power off if the AC input is less than 75 VAC +/- 5 VAC range. The power supply should start up if the AC input is greater than 85 VAC +/- 4 VAC. Application of an input voltage below 85 VAC shall not cause damage to the power supply, including a fuse blow.

Table 10. AC Input Rating

Parameter	Minimum	Rated	Maximum	Start up VAC	Power Off VAC
Voltage (110)	90 V _{rms}	100-127 V _{rms}	140 V _{rms}	85Vac +/-4Vac	75Vac +/-5Vac
Voltage (220)	180 V _{rms}	200-240 V _{rms}	264 V _{rms}		
Frequency	47 Hz		63 Hz		

3.5 Protection Circuits

Protection circuits inside the power supply should cause only the power supply's main outputs to shut down. If the power supply latches off due to a protection circuit tripping, an AC cycle off for 15 seconds and a PSON[#] cycle high for 1 second should be able to reset the power supply.

3.5.1 Over-current Protection (OCP)

The power supply should have current limit to prevent the +3.3 V, +5 V, and +12 V outputs from exceeding the values shown in the following table. If the current limits are exceeded, the power supply will shut down and latch off. You can clear the latch by toggling the PSON[#] signal or with an AC power interruption. The power supply should not be damaged from repeated power cycling in this condition. -12 V and 5 VSB should be protected under over-current or shorted conditions so no damage can occur to the power supply. Auto-recovery feature is a requirement on 5 VSB rail.

Table 11. Over-current Protection (OCP)

Voltage	Over-current Limit (I _{out} limit)
+3.3 V	110% minimum (= 16.5 A) ; 150% maximum (= 22.5 A)
+5 V	110% min (= 11.0 A); 150% max (= 15.0 A)
+12 V1	26 A min; 36 A max
+12 V2	10 A min; 15 A max
-12 V	0.625 A min; 2.0 A max
5 VSB	6.0 A max

3.5.2 Over-voltage Protection (OVP)

The power supply over-voltage protection should be locally sensed. The power supply will shut down and latch off after an over-voltage condition occurs. You can clear this latch by toggling the PSON[#] signal or with an AC power interruption. The following table contains the over-voltage limits. The values are measured at the output of the power supply's connectors. The voltage should never exceed the maximum levels when measured at the power pins of the power supply connector during any single point of fail. The voltage should never trip any lower than the minimum levels when measured at the power pins of the power supply connector.

Exception: +5 VSB rail should be able to recover after an over-voltage condition occurs.

Table 12. Over-Voltage Protection (OVP) Limits

Output Voltage	Minimum (V)	Maximum (V)
+3.3 V	3.9	4.5
+5 V	5.7	6.2
+12 V1,2	13.3	14.5
-12 V	-13.3	-14.5
+5 VSB	5.7	6.5

3.5.3 Over-temperature Protection (OTP)

The power supply is protected against over temperature conditions caused by loss of fan cooling or excessive ambient temperature. In an OTP condition, the power supply shuts down. When the power supply temperature drops to within specified limits, the power supply automatically restores power, while the 5 VSB remains always on. The OTP circuit must have built-in hysteresis such that the power supply will not oscillate on and off due to temperature recovering condition. The OTP trip level should have a minimum of 4° C of ambient temperature hysteresis.

3.6 AC Power Cord Specification Requirements

The AC power cord must meet the following specification requirements:

Cable Type	SJT
Wire size	16 AWG
Temperature rating	105° C
Amperage rating	13 A
Voltage rating	125 V

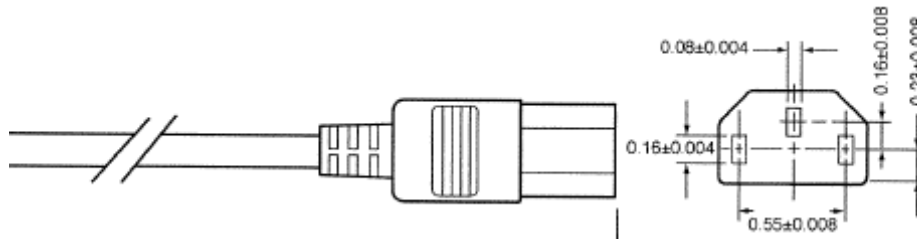

Figure 6. AC Power Cord Drawing

4. Cooling Sub-System

The cooling sub-system consists of two 97 x 94 x 33mm blower fans and a system air duct. These components are used to provide the necessary cooling and airflow to the system. A fan on the processor heat sink is not needed.

You must properly install the air duct and the top cover to maintain the required airflow within the system.

Note: The Intel® Server System SR1630BC does not support redundant cooling. If a fan blower fails, you must power down the system as soon as possible so you can replace the failed fan blower.

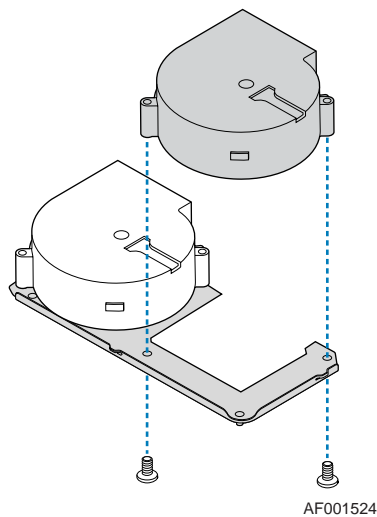

Figure 7. Fan Module Assembly – Intel® Server System SR1630BC

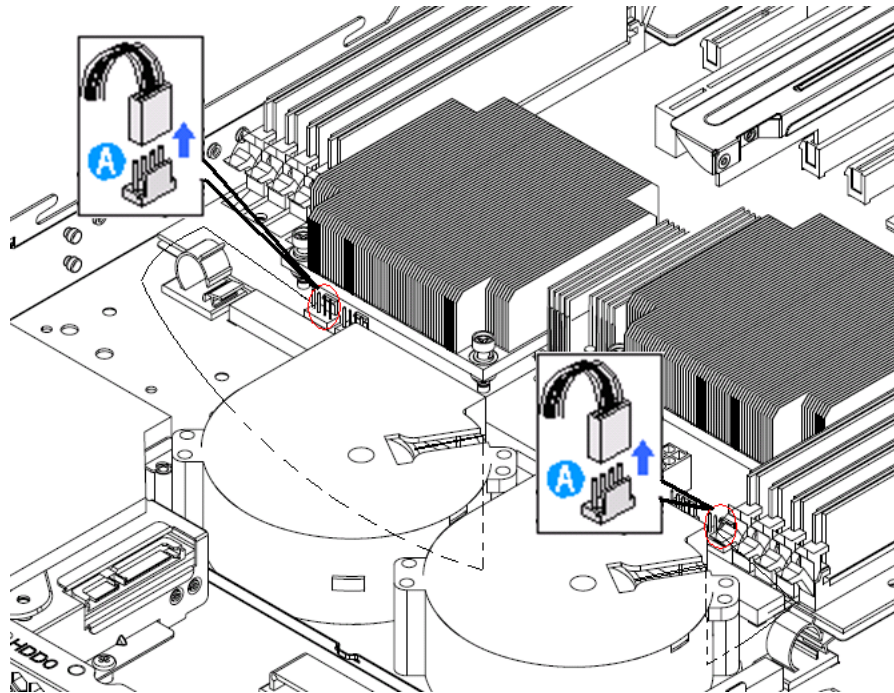

Table 13. Cooling Zones

Fan	Cooling Zone	Greatest Cooling Influence
System fan blower left	CPU2	Primary cooling for CPU2, system memory, and PCIE card on riser card
System fan blower right	CPU1	Primary cooling for CPU1, IOH, and system memory

4.1.1 System Fan Connectors

The Intel® Server System SR1630BC supports two system fan blowers. The pin-out for the connector is provided in the following table.

Table 14. System Fan Connector Pin-outs

J3K2 - SYS_FAN1		J8K3 - SYS_FAN2	
Pin	Signal Name	Pin	Signal Name
1	GND	1	GND
2	P12V	2	P12V
3	FAN_TACH	3	FAN_TACH
4	FAN_PWM_SYS1	4	FAN_PWM_SYS2

4.2 Power Supply Fans

The power supply incorporates two non-redundant 40 mm fans for self cooling. They are responsible for the cooling of the power supply.

4.3 Processor Air Duct and Air Baffle

The system requires the use of the system air duct to direct airflow and sustain appropriate air pressure.

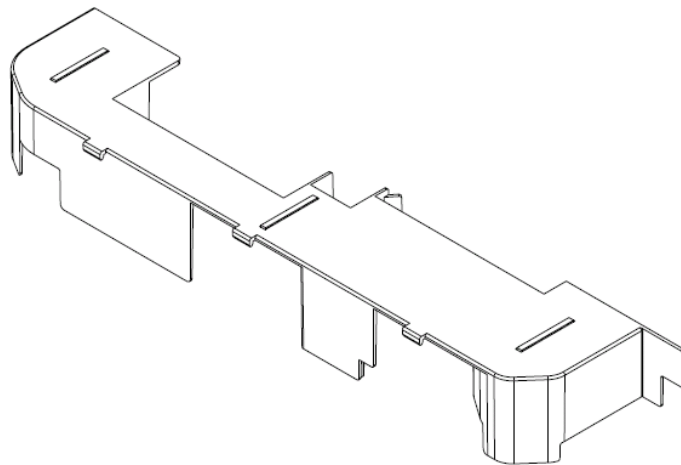
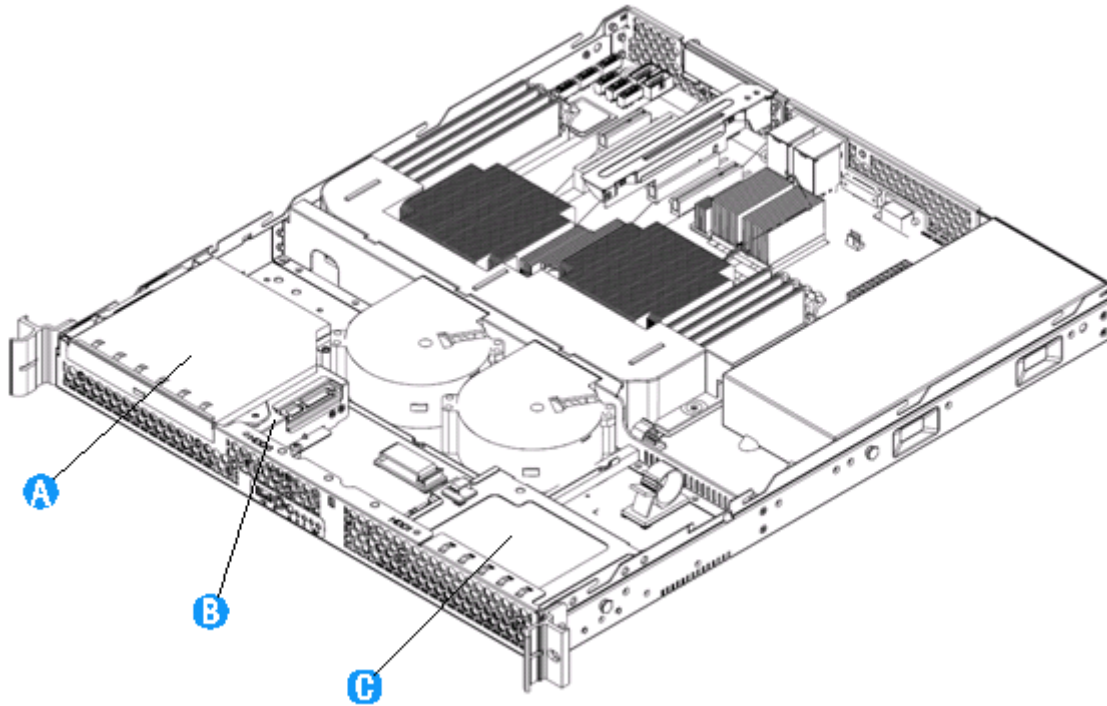

Figure 8. Air Duct for the Intel® Server System SR1630BC

5. Peripheral and Hard Drive Support

The Intel® Server System SR1630BC provides support for two fixed hard drive bays and one slim-line peripheral drive bay at the front of the system. The fixed hard drive bays are designed to support SATA 3.5-inch drives.



Item	Feature
A	Slimline optical drive bay
B	Hard drive bay HDD0 (located under the slim-line optical drive bay)
C	Hard drive bay HDD1

Figure 9. Peripheral Location

5.1 Optical Drive Support

The system provides a slimline drive bay that you can configure for a SATA optical CD-ROM or a DVD / CDR drive. Drives are mounted on a tray which allows for easy installation into and removal from the system. The slimline devices are not hot-swappable.

5.1.1 Optical Drive Support

The systems support a slimline SATA optical drive. The drive is mounted onto a drive tray. The drive assembly is then inserted in to the slim-line drive bay. A SATA cable connects the drive assembly to a SATA connector on the server board.

5.2 Hard Disk Drive Support

The Intel® Server System SR1630BC can support up to two 3.5-inch by 1-inch fixed SATA hard disk drives. The drives are mounted inside the systems.

6. Front Control Panel

The standard control panel supports a power button, status LED, hard drive activity LED, and NIC 1 and NIC 2 activity LEDs. The control panel assembly comes pre-assembled into the system. The control panel assembly module slides into a predefined slot on the front of the system. Once installed, communication to the server board can be achieved through a standard 24-pin cable connected directly to the server board.

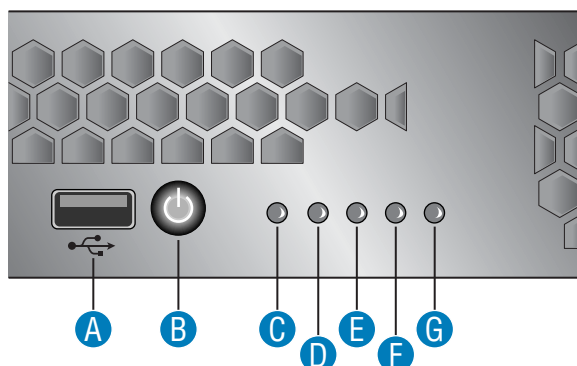

AF001000

Item	Feature
A	USB port
B	Power button. This button also functions as a sleep button if enabled by an ACPI-compliant operating system.
C	Status LED
D	System power LED
E	Hard drive activity LED
F	NIC 1 LED
G	NIC 2 LED

Figure 10. Front Control Panel – Intel® Server System SR1630BC

Table 15. Control Panel LED Functions

LED	Color	State	Description
NIC1 / NIC2 Activity	Green	On	NIC Link/no access
	Green	Blink	LAN access
Power / Sleep (on standby power)	Green	On	Power on
		Blink	Sleep / ACPI S1 state
	Off	Off	Power Off / ACPI S4 state
System Status (on standby power)	Green	On	Running / normal operation
		Blink	System ready, but degraded
	Amber	On	Critical or non-recoverable condition. Possible critical power module failure, critical fan failure, voltage (power supply), voltage and thermal fault
		Blink	Non-critical condition.
	Off	Off	POST / system stop. System not ready

LED	Color	State	Description
Disk Activity	Green	Random blink	HDD access
	Off	Off	No hard disk activity

The current limiting resistors for the power LED, system fault LED, and NIC LEDs are located on the Intel® Server Board S5500BC.

6.1.1 Power / Sleep LED

Table 16. SSI Power LED Operation

State	Power Mode	LED	Description
Power Off	Non-ACPI	Off	System power is off, and the BIOS has not initialized the chipset.
Power On	Non-ACPI	On	System power is on, but the BIOS has not yet initialized the chipset.
S5	ACPI	Off	Mechanical is off, and the operating system has not saved any context to the hard disk (soft-off state).
S4	ACPI	Off	Mechanical is off. The operating system has saved context to the hard disk (hibernate state).
S3-S1	ACPI	Slow blink ¹	DC power is still on. The operating system has saved context and gone into a level of low-power state (sleep state).
S0	ACPI	Steady on	System and the operating system are up and running (working state).

Note:

1. The blink rate is ~ 1Hz with at 50% duty cycle.

6.1.2 System Status LED

Table 17. Control Panel LED Operation

Color	State	Criticality	Description
Off	N/A	Not ready	System not ready: Post error/NMI event/PCI or terminator missing
Green	Solid on	Ok	System booted and ready
Green	Blink	Degraded	<p>System degraded</p> <ul style="list-style-type: none"> ▪ Unable to use all of the installed memory (more than one DIMM installed). ▪ Correctable errors over a threshold of 10 and migrating to a spare DIMM (memory sparing). This indicates that the user no longer has spared DIMMs indicating a redundancy lost condition. Corresponding DIMM LED should light up. ▪ In mirrored configuration, when memory mirroring takes place and system loses memory redundancy. ▪ Redundancy loss such as power-supply or fan. This does not apply to non-redundant sub-systems. ▪ PCI Express* link errors ▪ CPU failure / disabled – if there are two processors and one of them fails ▪ Fan alarm – Fan failure. Number of operational fans should be more than minimum number needed to cool the system ▪ Non-critical threshold crossed – Temperature and voltage

Color	State	Criticality	Description
Amber	Blink	Non-critical	Non-fatal alarm – system is likely to fail <ul style="list-style-type: none"> ▪ Critical voltage threshold crossed ▪ VRD hot asserted ▪ Minimum number of fans to cool the system not present or failed ▪ In non-sparing and non-mirroring mode if the threshold of ten correctable errors is crossed within the window
Amber	Solid on	Critical, non-recoverable	Fatal alarm – system has failed or shutdown <ul style="list-style-type: none"> ▪ DIMM failure when there is one DIMM present, no good memory present ▪ Run-time memory uncorrectable error in non-redundant mode ▪ IERR signal asserted ▪ Processor 1 missing ▪ Temperature (CPU ThermTrip, memory TempHi, critical threshold crossed) ▪ No power good – power fault ▪ Processor configuration error (for example, processor stepping mismatch)

6.1.3 Drive Activity LED

The drive activity LED on the front panel indicates drive activity from the onboard hard disk controllers.

7. PCI Riser Cards and Assembly

The Intel® Server Board S5500BC provides one PCI Express* x8 slot which supports one riser card with one riser card slot. The riser card supports one low-profile PCI Express* x8 add-in card which consumes power less than 15 W.

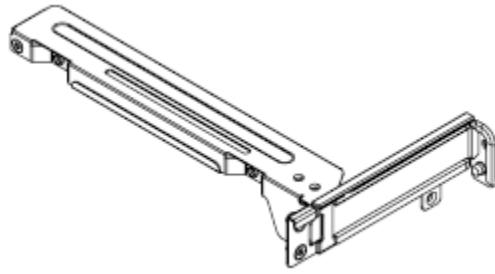

Figure 11. PCI Riser Card Assembly

8. Supported Intel® Server Boards

The systems are mechanically and functionally designed to support the Intel® Server Board S5500BC. See the technical product specification for the server board for detailed server board information.

8.1 Intel® Server Board S5500BC Feature Set

Feature	Description
Processors	LGA 1366 sockets supporting up to two Intel® Xeon® processor 5500 series with Intel® QuickPath Interconnect (QPI) and Integrated Memory controllers.
Memory	Eight DDR3 DIMM slots supporting DDR3 800/1066/1333 MT/s ECC Registered DIMM and ECC or Non-ECC unbuffered DIMM. Four slots support CPU_1 and four slots support CPU_2.
Chipset	Intel® 5500 chipset I/O Hub (IOH) Intel® 82801Jx I/O Controller Hub ServerEngines* LLC Pilot II BMC controller (Integrated BMC)
On-board Connectors / Headers	<ul style="list-style-type: none"> Eight 240-Pin DDR3 DIMM connectors Three PCI Express* Gen2 x8 connector One PCI Express* Gen1 x4 connector One 5V 32bit/33Mhz PCI connector Two stacked RJ-45 with Magnetics and LEDs and two-USB combo connectors One external Serial Port header (9 pin) Two internal USB 2x5 pin heards, each supports two USB 2.0 ports One 24-pin main power connector One 8-pin CPU power connector One 5-pin auxiliary power connector One DB-15 VGA connector One DB-9 Serial port connector Six 7-Pin SATAII connectors One 4-Pin SGPIO connector Five 4-pin, 0.10-inch pitch fan headers One 24-Pin Front Panel connector One 2-Pin Chassis Intrusion header One Intel® Remote Management Module 3 connector

Feature	Description
Add-in PCI, PCI Express* Cards	Slot6: One half-length (6.6 inches) PCI Express* Gen2 x8 connector with X8 link width (support riser card) Slot7 : One half-length (6.6 inches) PCI Express* Gen2 x8 connector with x8 link width Slot5 : One half-length (6.6 inches) PCI Express* Gen2 x8 connector with x4 link width Slot3 : One half-length (6.6 inches) PCI Express* x4 connector with x4 link width Slot4 : One half-length (6.6 inches) 5V PCI 32 bit / 33 MHz connector
On-board Video	Onboard ServerEngines* LLC Pilot II BMC controller <ul style="list-style-type: none"> • Integrated 2D video controller • 32 MB DDR2 667 MHz Memory
On-board Hard Drive Controller	Support up to six Serial ATA II hard drives through six onboard SATA II connectors
LAN	Two 10/100/1000 NICs <ul style="list-style-type: none"> ▪ One 82574LGbE PCI Express* Network Controller connects to the Gen2 x1 interface on the Intel® 5500 IOH chipset. ▪ One 82567 Gigabit Network Connection that connects to the Gigabit LAN Connect Interface / LAN Connect Interface on the Intel® ICH10R ▪ Two 10/100/1000 Base-TX Interfaces through RJ-45 connectors with integrated magnetics. ▪ Link and Speed LEDs on the RJ-45 Connector.
System Fans	Five 4-pin fan headers supporting two processor fans and three system fans
USB	Four USB 2.0 Ports connected to the Rear Panel Four USB 2.0 Ports connected to Headers on the mother board One USB 1.1 Port connected to Integrated BMC for KB/MS function. One USB 2.0 Port connected to Integrated BMC for remote storage function.
Power Supply	One main power connector On-board power generation VRD 11.1 processor Core Voltage 1.2 V Regulator for Processor VTT 1.1 V Regulator for IOH Core and IO 1.05 V Regulator for Intel® ICH10 Core 1.5 V Regulator for the Intel® ICH10 1.5 V for DDR3 and 0.75 V for DDR3 Termination 3.3 V SB Voltage regulator 1.8 V AUX, 1.2 V AUX, and 0.9 V AUX for the integrated BMC and DDR2 memory in it
System Management	Processor on die temperature monitoring from the PECL interface Board temperature measurement Fan speed monitoring & control Voltage Monitoring IPMI based server management

9. Environmental and Regulatory Specifications

9.1 System Level Environmental Limits

The following table defines the system level operating and non-operating environmental limits

Table 18. System Environmental Limits Summary

Parameter	Limits
Operating Temperature	+10° C to +35° C with the maximum rate of change not to exceed 10° C per hour
Non-Operating Temperature	-40° C to +70° C
Non-Operating Humidity	90%, non-condensing at 35° C
Acoustic noise	Sound power: 7.0 BA in an idle state at typical office ambient temperature. (23 +/- 2 degrees C)
Shock, operating	Half sine, 2 g peak, 11 mSec
Shock, unpackaged	Trapezoidal, 25 g, velocity change 136 inches/sec (≥ 40 lbs to > 80 lbs)
Shock, packaged	Non-palletized free fall in height of 24 inches (≥ 40 lbs to > 80 lbs)
Vibration, unpackaged	5 Hz to 500 Hz, 2.20 g RMS random
Shock, operating	Half sine, 2 g peak, 11 mSec
ESD*	+/-15 KV except I/O port +/-8 KV per the Intel Environmental test specification
System Cooling Requirement in BTU/Hr	2550 BTU/hour

* **IMPORTANT NOTES:** *The host system with the Server Board S5500BC requires the use of shielded LAN cable to comply with Immunity regulatory requirements. Use of non-shielded cables may result in the product having insufficient immunity electromagnetic effects, which may cause improper operation of the product.*

9.2 Serviceability and Availability

The system is designed to be serviced by qualified technical personnel only.

The desired Mean Time To Repair (MTTR) of the system is 30 minutes including diagnosis of the system problem. To meet this goal, the system enclosure and hardware were designed to minimize the MTTR.

Following are the maximum times that a trained field service technician should take to perform the listed system maintenance procedures, after diagnosis of the system and having identified the failed component.

Activity	Time Estimate
Remove cover	1 min
Remove and replace hard disk drive	5 min
Remove and replace power supply module	1 min
Remove and replace system fan	7 min
Remove and replace control panel module	2 min
Remove and replace baseboard	15 min

9.3 Replacing the CMOS Battery

The lithium battery on the server board powers the real time clock (RTC) for several years in the absence of power. When the battery starts to weaken, it loses voltage, and the server settings stored in CMOS RAM in the RTC (for example, the date and time) may be wrong. Contact your customer service representative or dealer for a list of approved devices.

**WARNING**

Danger of explosion if battery is incorrectly replaced. Replace only with the same or equivalent type recommended by the equipment manufacturer. Discard used batteries according to manufacturer's instructions.

**ADVARSEL!**

Lithiumbatteri - Eksplosionsfare ved fejlagtig håndtering. Udskiftning må kun ske med batteri af samme fabrikat og type. Levér det brugte batteri tilbage til leverandøren.

**ADVARSEL**

Lithiumbatteri - Eksplosjonsfare. Ved utskifting benyttes kun batteri som anbefalt av apparatfabrikanten. Brukt batteri returneres apparatleverandøren.

**WARNING**

Explosionsfara vid felaktigt batteribyte. Använd samma batterityp eller en ekvivalent typ som rekommenderas av apparattillverkaren. Kassera använt batteri enligt fabrikantens instruktion.

**VAROITUS**

Paristo voi räjähtää, jos se on virheellisesti asennettu. Vaihda paristo ainoastaan laitevalmistajan suosittelemaan tyyppiin. Hävitä käytetty paristo valmistajan ohjeiden mukaisesti.

9.4 Product Regulatory Compliance

The server chassis product, when correctly integrated per this guide, complies with the following safety and electromagnetic compatibility (EMC) regulations.

Intended Application – This product was evaluated as Information Technology Equipment (ITE), which may be installed in offices, schools, computer rooms, and similar commercial type locations. The suitability of this product for other product categories and environments (such as: medical, industrial, telecommunications, NEBS, residential, alarm systems, test equipment, etc.), other than an ITE application, may require further evaluation.

Notifications to Users on Product Regulatory Compliance and Maintaining Compliance

To ensure regulatory compliance, you must adhere to the assembly instructions in this guide to ensure and maintain compliance with existing product certifications and approvals. Use only the described, regulated components specified in this guide. Use of other products / components will void the UL listing and other regulatory approvals of the product and will most likely result in noncompliance with product regulations in the region(s) in which the product is sold.

To help ensure EMC compliance with your local regional rules and regulations, before computer integration, make sure that the chassis, power supply, and other modules have passed EMC testing using a server board with a microprocessor from the same family (or higher) and operating at the same (or higher) speed as the microprocessor used on this server board. The final configuration of your end system product may require additional EMC compliance testing. For more information please contact your local Intel Representative. This is an FCC Class A device and its use is intended for a commercial type market place.

9.5 Use of Specified Regulated Components

To maintain the UL listing and compliance to other regulatory certifications and/or declarations, the following regulated components must be used and conditions adhered to. Interchanging or use of other component will void the UL listing and other product certifications and approvals. Updated product information for configurations can be found on the Intel Server Builder Web site at the following URL:

<http://www.intel.com/go/serverbuilder>

If you do not have access to Intel's Web address, please contact your local Intel representative.

Server chassis (base chassis is provided with power supply and fans)—UL listed.

Server board—you must use an Intel server board—UL recognized.

Add-in boards—must have a printed wiring board flammability rating of minimum UL94V-

1. Add-in boards containing external power connectors and/or lithium batteries must be UL recognized or UL listed. Any add-in board containing modem telecommunication circuitry must be UL listed. In addition, the modem must have the appropriate telecommunications, safety, and EMC approvals for the region in which it is sold.





Peripheral Storage Devices - must be UL recognized or UL listed accessory and TUV or VDE licensed. Maximum power rating of any one device or combination of devices





can not exceed manufacturer's specifications. Total server configuration is not to exceed the maximum loading conditions of the power supply.

The following table references Server Chassis Compliance and markings that may appear on the product. Markings below are typical markings however, may vary or be different based on how certification is obtained.

Note: The Intel® Server System SR1630BC meets Class A Certifications Emissions requirements.

Table 19. Product Safety & Electromagnetic (EMC) Compliance

Compliance Regional Description	Compliance Reference	Compliance Reference Marking Example
Australia / New Zealand	AS/NZS 3548 (Emissions)	 N232
Argentina	IRAM Certification (Safety)	
Belarus	Belarus Certification	None Required
Canada / USA	CSA 60950 – UL 60950 (Safety)	
	Industry Canada ICES-003 (Emissions)	CANADA ICES-003 CLASS A CANADA NMB-003 CLASSE A
	FCC CFR 47, Part 15 (Emissions)	This device complies with Part 15 of the FCC Rules. Operation of this device is subject to the following two conditions: (1) This device may not cause harmful interference, and (2) This device must accept interference receive, including interference that may cause undesired operation.
China	CNCA – CB4943 (Safety) GB 9254 (Emissions) GB17625 (Harmonics)	
CENELEC Europe	Low Voltage Directive 93/68/EEC; EMC Directive 89/336/EEC EN55022 (Emissions) EN55024 (Immunity) EN61000-3-2 (Harmonics) EN61000-3-3 (Voltage Flicker) CE Declaration of Conformity	

Compliance Regional Description	Compliance Reference	Compliance Reference Marking Example
Germany	GS Certification – EN60950	
International	CB Certification – IEC60950 CISPR 22 / CISPR 24	None Required
Japan	VCCI Certification	<p>この装置は、クラス A 情報技術装置です。この装置を家庭環境で使用すると電波妨害を引き起こすことがあります。この場合には使用者が適切な対策を講ずるよう要求されることがあります。VCCI-A</p>
Korea	RRL Certification MIC Notice No. 1997-41 (EMC) & 1997-42 (EMI)	 인증번호: CPU-Model Name (A)
Russia	GOST-R Certification GOST R 29216-91 (Emissions) GOST R 50628-95 (Immunity)	
Ukraine	Ukraine Certification	None Required
Taiwan	BSMI CNS13438	 R33025 <div style="border: 1px solid black; padding: 5px; margin-top: 10px;"> <p>警告使用者： 這是甲類的資訊產品，在居住的環境中使用時，可能會造成射頻干擾，在這種情況下，使用者會被要求採取某些適當的對策</p> </div>

9.6 Electromagnetic Compatibility Notices

9.6.1 USA

This device complies with Part 15 of the FCC Rules. Operation is subject to the following two conditions: (1) this device may not cause harmful interference, and (2) this device must accept any interference received, including interference that may cause undesired operation.

For questions related to the EMC performance of this product, contact:

Intel Corporation
5200 N.E. Elam Young Parkway
Hillsboro, OR 97124
1-800-628-8686

This equipment has been tested and found to comply with the limits for a Class A digital device, pursuant to Part 15 of the FCC Rules. These limits are designed to provide reasonable protection against harmful interference in a residential installation. This equipment generates, uses, and can radiate radio frequency energy and, if not installed and used in accordance with the instructions, may cause harmful interference to radio communications. However, there is no guarantee that interference will not occur in a particular installation. If this equipment does cause harmful interference to radio or television reception, which can be determined by turning the equipment off and on, the user is encouraged to try to correct the interference by one or more of the following measures:

- Reorient or relocate the receiving antenna.
- Increase the separation between the equipment and the receiver.
- Connect the equipment to an outlet on a circuit other than the one to which the receiver is connected.
- Consult the dealer or an experienced radio/TV technician for help.

Any changes or modifications not expressly approved by the grantee of this device could void the user's authority to operate the equipment. The customer is responsible for ensuring compliance of the modified product.

Only peripherals (computer input/output devices, terminals, printers, etc.) that comply with FCC Class B limits may be attached to this computer product. Operation with noncompliant peripherals is likely to result in interference to radio and TV reception.

All cables used to connect to peripherals must be shielded and grounded. Operation with cables, connected to peripherals that are not shielded and grounded may result in interference to radio and TV reception.

9.6.2 FCC Verification Statement

Product Type: SR1630; S5500BC

This device complies with Part 15 of the FCC Rules. Operation is subject to the following two conditions: (1) This device may not cause harmful interference, and (2) this device must accept any interference received, including interference that may cause undesired operation.

For questions related to the EMC performance of this product, contact:

Intel Corporation
5200 N.E. Elam Young Parkway
Hillsboro, OR 97124-6497

Phone: 1 (800)-INTEL4U or 1 (800) 628-8686

9.6.3 ICES-003 (Canada)

Cet appareil numérique respecte les limites bruits radioélectriques applicables aux appareils numériques de Classe A prescrites dans la norme sur le matériel brouilleur: "Appareils Numériques", NMB-003 édictée par le Ministre Canadian des Communications.

(English translation of the notice above) This digital apparatus does not exceed the Class A limits for radio noise emissions from digital apparatus set out in the interference-causing equipment standard entitled "Digital Apparatus," ICES-003 of the Canadian Department of Communications.

9.6.4 Europe (CE Declaration of Conformity)

This product has been tested in accordance too, and complies with the Low Voltage Directive (73/23/EEC) and EMC Directive (89/336/EEC). The product has been marked with the CE Mark to illustrate its compliance.

9.6.5 Japan EMC Compatibility

Electromagnetic Compatibility Notices (International)

この装置は、情報処理装置等電波障害自主規制協議会（VCCI）の基準に基づくクラス A 情報技術装置です。この装置を家庭環境で使用すると電波妨害を引き起こすことがあります。この場合には使用者が適切な対策を講ずるよう要求されることがあります。

English translation of the notice above:

This is a Class A product based on the standard of the Voluntary Control Council For Interference (VCCI) from Information Technology Equipment. If this is used near a radio or television receiver in a domestic environment, it may cause radio interference. Install and use the equipment according to the instruction manual.

9.6.6 BSMI (Taiwan)

The BSMI Certification number and the following warning is located on the product safety label which is located on the bottom side (pedestal orientation) or side (rack mount configuration).

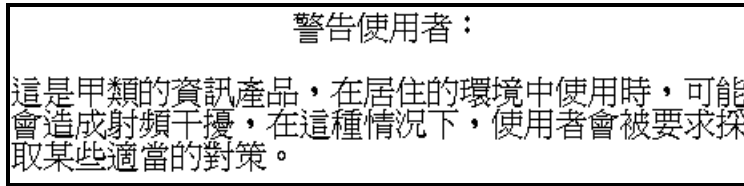

9.6.7 RRL (Korea)

Following is the RRL certification information for Korea.

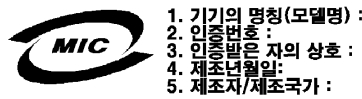

English translation of the notice above:

1. Type of Equipment (Model Name): On License and Product
2. Certification No.: On RRL certificate. Obtain certificate from local Intel representative
3. Name of Certification Recipient: Intel Corporation
4. Date of Manufacturer: Refer to date code on product
5. Manufacturer/Nation: Intel Corporation/Refer to country of origin marked on product



9.6.8 CNCA (CCC-China)

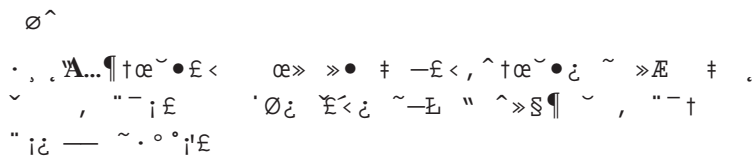



The CCC Certification Marking and EMC warning is located on the outside rear area of the product.



9.7 Product Ecology Compliance

Intel has a system in place to restrict the use of banned substances in accordance with world wide product ecology regulatory requirements. The following is Intel's product ecology compliance criteria.

Compliance Regional Description	Compliance Reference	Compliance Reference Marking Example
California	California Code of Regulations, Title 22, Division 4.5; Chapter 33: Best Management Practices for Perchlorate Materials.	Special handling may apply. See www.dtsc.ca.gov/hazardouswaste/perchlorate This notice is required by California Code of Regulations, Title 22, Division 4.5; Chapter 33: Best Management Practices for Perchlorate Materials. This product / part includes a battery which contains Perchlorate material.
China	<p>China RoHS Administrative Measures on the Control of Pollution Caused by Electronic Information Products” (EIP) #39. Referred to as China RoHS. Mark requires to be applied to retail products only. Mark used is the Environmental Friendly Use Period (EFUP). Number represents years.</p>	
	<p>China Recycling (GB18455-2001) Mark requires to be applied to be retail product only. Marking applied to bulk packaging and single packages. Not applied to internal packaging such as plastics, foams, etc.</p>	
Intel Internal Specification	All materials, parts and subassemblies must not contain restricted materials as defined in Intel's Environmental Product Content Specification of Suppliers and Outsourced Manufacturers – http://supplier.intel.com/ehs/environmental.htm	None Required
Europe	<p>Waste Electrical and Electronic Equipment (WEEE) Directive 2002/96/EC – Mark applied to system level products only.</p>	
	<p>European Directive 2002/95/EC - Restriction of Hazardous Substances (RoHS) Threshold limits and banned substances are noted below. Quantity limit of 0.1% by mass (1000 PPM) for: Lead, Mercury, Hexavalent Chromium, Polybrominated Biphenyls Diphenyl Ethers (PBB/PBDE) Quantity limit of 0.01% by mass (100 PPM) for: Cadmium</p>	None Required

Compliance Regional Description	Compliance Reference	Compliance Reference Marking Example	
Germany	German Green Dot Applied to Retail Packaging Only for Boxed Boards		
Intel Internal Specification	All materials, parts and subassemblies must not contain restricted materials as defined in Intel's Environmental Product Content Specification of Suppliers and Outsourced Manufacturers – http://supplier.intel.com/ehs/environmental.htm	None Required	
International	ISO11469 - Plastic parts weighing >25gm are intended to be marked with per ISO11469. Recycling Markings – Fiberboard (FB) and Cardboard (CB) are marked with international recycling marks. Applied to outer bulk packaging and single package.	>PC/ABS< 	 Corrugated Recycles
Japan	Japan Recycling Applied to Retail Packaging Only for Boxed Boards	 内袋	

9.8 Other Markings

Compliance Description	Compliance Reference	Compliance Reference Marking Example
Stand-by Power	60950 Safety Requirement Applied to product is stand-by power switch is used.	
Multiple Power Cords	60950 Safety Requirement Applied to product if more than one power cord is used.	<p>English: This unit has more than one power supply cord. To reduce the risk of electrical shock, disconnect (2) two power supply cords before servicing.</p> <p>Simplified Chinese: 注意： 本设备包括多条电源系统电缆。为避免遭受电击，在进行维修之前应断开两（2）条电源系统电缆。</p> <p>Traditional Chinese: 注意： 本設備包括多條電源系統電纜。為避免遭受電擊，在進行維修之前應斷開兩（2）條電源系統電纜。</p> <p>German: Dieses Geräte hat mehr als ein Stromkabel. Um eine Gefahr des elektrischen Schlages zu verringern trennen sie beide (2) Stromkabeln bevor Instandhaltung.</p>
Ground Connection	60950 Deviation for Nordic Countries	<p>Line1 : "WARNING:"</p> <p>Swedish on line2: "Apparaten skall anslutas till jordat uttag, när den ansluts till ett nätverk."</p> <p>Finnish on line 3: "Laite on liitettävä suojamaadoituskoskettimilla varustettuun pistorasiaan."</p> <p>English on line 4: "Connect only to a properly earth grounded outlet."</p>
Country of Origin	Logistic Requirements Applied to products to indicate where product was made.	Made in XXXX

This page intentionally left blank

Appendix A: Integration and Usage Tips

This section provides a list of useful information unique to the Intel® Server System SR1630BC and should be kept in mind while integrating and server system.

- The system with the Server Board S5500BC requires the use of shielded LAN cable to comply with Immunity regulatory requirements.
- You cannot use Intel® Remote Management Module 3 in the system.
- The system supports one riser card that supports one low-profile PCI Express* x8 add-in card which consumes power less than 15 W.
- Processor fans are not needed and are not supported. The system fan module provides the necessary cooling needed for the system.
- You must use the system air duct to maintain system thermals.
- System fans are not hot-swappable.
- A screw on the front edge of the top cover is required when the unit is installed in a user-accessible environment.
- The FRUSDR utility must be run to load the proper sensor data records for the server chassis onto the server board.
- Make sure the latest system software is loaded. This includes system BIOS, FRUSDR, and BMC firmware. You can download the latest system software from:
<http://support.intel.com/support/motherboards/server/S5500BC/>

Appendix B: POST Code Diagnostic LED Decoder

The BIOS executes platform configuration processes during the system boot. Each process is assigned a specific hex POST code number. As each configuration routine is started, the BIOS displays the POST code on the POST Code Diagnostic LEDs on the back edge of the server board. The Diagnostic LEDs identify the last POST process executed.

Each POST code is represented by eight amber Diagnostic LEDs. The POST codes are divided into two nibbles, an upper nibble and a lower nibble. The upper nibble bits are represented by Diagnostic LEDs #4, #5, #6, #7. The lower nibble bits are represented by Diagnostics LEDs #0, #1, #2 and #3. Given the bit is set in the upper and lower nibbles, and then corresponding LED is lit. If the bit is clear, the corresponding LED is off.

Diagnostic LED #7 is labeled as “MSB”, and the Diagnostic LED #0 is labeled as “LSB”.

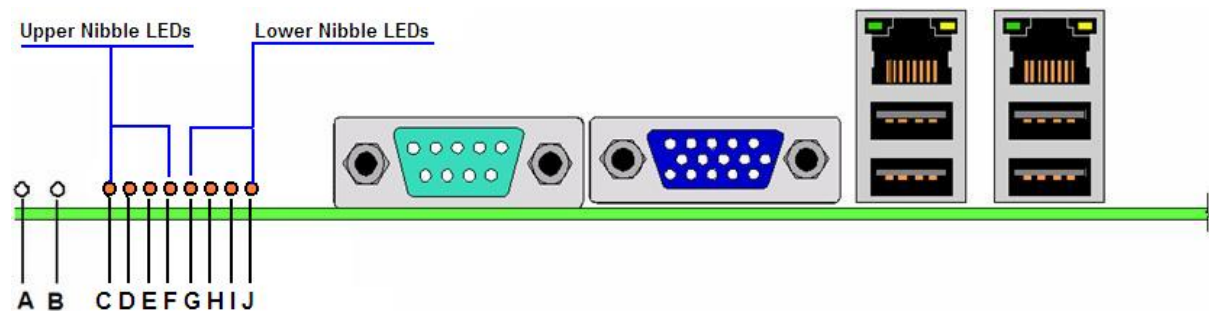

A. ID LED	F. Diagnostic LED #4
B. Status LED	G. Diagnostic LED #3
C. Diagnostic LED #7 (MSB LED)	H. Diagnostic LED #2
D. Diagnostic LED #6	I. Diagnostic LED #1
E. Diagnostic LED #5	J. Diagnostic LED #0 (LSB LED)

Figure 12. Diagnostic LED Placement Diagram

In the following example, the BIOS sends a value of ACh to the diagnostic LED decoder. The LEDs are decoded as follows:

Table 20. POST Progress Code LED Example

	Upper Nibble LEDs				Lower Nibble LEDs			
	MSB							LSB
	LED #7	LED #6	LED #5	LED #4	LED #3	LED #2	LED #1	LED #0
	8h	4h	2h	1h	8h	4h	2h	1h
Status	ON	OFF	ON	OFF	ON	ON	OFF	OFF
	1	0	1	0	1	1	0	0
	Ah				Ch			

Upper nibble bits = 1010b = Ah; Lower nibble bits = 1100b = Ch; The two are concatenated as ACh.

Table 21. Diagnostic LED POST Code Decoder

Checkpoint	Diagnostic LED Decoder								Description
	O = On, X=Off								
	Upper Nibble				Lower Nibble				
	MSB							LSB	
LED	8h	4h	2h	1h	8h	4h	2h	1h	
	#7	#6	#5	#4	#3	#2	#1	#0	
Host Processor									
0x10h	X	X	X	O	X	X	X	X	Power-on initialization of the host processor (bootstrap processor)
0x11h	X	X	X	O	X	X	X	O	Host processor cache initialization (including AP)
0x12h	X	X	X	O	X	X	O	X	Starting application processor initialization
0x13h	X	X	X	O	X	X	O	O	SMM initialization
Chipset									
0x21h	X	X	O	X	X	X	X	O	Initializing a chipset component
Memory									
0x22h	X	X	O	X	X	X	O	X	Reading configuration data from memory (SPD on DIMM)
0x23h	X	X	O	X	X	X	O	O	Detecting presence of memory
0x24h	X	X	O	X	X	O	X	X	Programming timing parameters in the memory controller
0x25h	X	X	O	X	X	O	X	O	Configuring memory parameters in the memory controller
0x26h	X	X	O	X	X	O	O	X	Optimizing memory controller settings
0x27h	X	X	O	X	X	O	O	O	Initializing memory, such as ECC init
0x28h	X	X	O	X	O	X	X	X	Testing memory
PCI Bus									
0x50h	X	O	X	O	X	X	X	X	Enumerating PCI buses
0x51h	X	O	X	O	X	X	X	O	Allocating resources to PCI buses
0x52h	X	O	X	O	X	X	O	X	Hot Plug PCI controller initialization
0x53h	X	O	X	O	X	X	O	O	Reserved for PCI bus
0x54h	X	O	X	O	X	O	X	X	Reserved for PCI bus
0x55h	X	O	X	O	X	O	X	O	Reserved for PCI bus
0x56h	X	O	X	O	X	O	O	X	Reserved for PCI bus
0x57h	X	O	X	O	X	O	O	O	Reserved for PCI bus
USB									
0x58h	X	O	X	O	O	X	X	X	Resetting USB bus
0x59h	X	O	X	O	O	X	X	O	Reserved for USB devices
ATA/ATAPI/SATA									
0x5Ah	X	O	X	O	O	X	O	X	Resetting SATA bus and all devices
0x5Bh	X	O	X	O	O	X	O	O	Reserved for ATA
SMBUS									
0x5Ch	X	O	X	O	O	O	X	X	Resetting SMBUS
0x5Dh	X	O	X	O	O	O	X	O	Reserved for SMBUS
Local Console									
0x70h	X	O	O	O	X	X	X	X	Resetting the video controller (VGA)
0x71h	X	O	O	O	X	X	X	O	Disabling the video controller (VGA)
0x72h	X	O	O	O	X	X	O	X	Enabling the video controller (VGA)
Remote Console									
0x78h	X	O	O	O	O	X	X	X	Resetting the console controller
0x79h	X	O	O	O	O	X	X	O	Disabling the console controller
0x7Ah	X	O	O	O	O	X	O	X	Enabling the console controller
Keyboard (only USB)									
0x90h	O	X	X	O	X	X	X	X	Resetting the keyboard
0x91h	O	X	X	O	X	X	X	O	Disabling the keyboard
0x92h	O	X	X	O	X	X	O	X	Detecting the presence of the keyboard
0x93h	O	X	X	O	X	X	O	O	Enabling the keyboard
0x94h	O	X	X	O	X	O	X	X	Clearing keyboard input buffer
0x95h	O	X	X	O	X	O	X	O	Instructing keyboard controller to run Self Test(PS/2 only)
Mouse (only USB)									
0x98h	O	X	X	O	O	X	X	X	Resetting the mouse
0x99h	O	X	X	O	O	X	X	O	Detecting the mouse
0x9Ah	O	X	X	O	O	X	O	X	Detecting the presence of mouse
0x9Bh	O	X	X	O	O	X	O	O	Enabling the mouse
Fixed Media									
0xB0h	O	X	O	O	X	X	X	X	Resetting fixed media device

Checkpoint	Diagnostic LED Decoder								Description
	O = On, X=Off								
	Upper Nibble				Lower Nibble				
	MSB							LSB	
LED	8h	4h	2h	1h	8h	4h	2h	1h	
	#7	#6	#5	#4	#3	#2	#1	#0	
0xB1h	O	X	O	O	X	X	X	O	Disabling fixed media device
0xB2h	O	X	O	O	X	X	O	X	Detecting presence of a fixed media device (hard drive detection, etc.)
0xB3h	O	X	O	O	X	X	O	O	Enabling / configuring a fixed media device
Removable Media									
0xB8h	O	X	O	O	O	X	X	X	Resetting removable media device
0xB9h	O	X	O	O	O	X	X	O	Disabling removable media device
0xBAh	O	X	O	O	O	X	O	X	Detecting presence of a removable media device (CDROM detection, and so forth.)
0xBCh	O	X	O	O	O	O	X	X	Enabling / configuring a removable media device
Boot Device Selection (BDS)									
0xD0	O	O	X	O	X	X	X	X	Trying to boot device selection 0
0xD1	O	O	X	O	X	X	X	O	Trying to boot device selection 1
0xD2	O	O	X	O	X	X	O	X	Trying to boot device selection 2
0xD3	O	O	X	O	X	X	O	O	Trying to boot device selection 3
0xD4	O	O	X	O	X	O	X	X	Trying to boot device selection 4
0xD5	O	O	X	O	X	O	X	O	Trying to boot device selection 5
0xD6	O	O	X	O	X	O	O	X	Trying to boot device selection 6
0xD7	O	O	X	O	X	O	O	O	Trying to boot device selection 7
0xD8	O	O	X	O	O	X	X	X	Trying to boot device selection 8
0xD9	O	O	X	O	O	X	X	O	Trying to boot device selection 9
0xDA	O	O	X	O	O	X	O	X	Trying to boot device selection A
0xDB	O	O	X	O	O	X	O	O	Trying to boot device selection B
0xDC	O	O	X	O	O	O	X	X	Trying to boot device selection C
0xDD	O	O	X	O	O	O	X	O	Trying to boot device selection D
0xDE	O	O	X	O	O	O	O	X	Trying to boot device selection E
0xDF	O	O	X	O	O	O	O	O	Trying to boot device selection F
Pre-EFI Initialization (PEI) Core									
0xE0h	O	O	O	X	X	X	X	X	Started dispatching early initialization modules (PEIM)
0xE1h	O	O	O	X	X	X	X	O	Reserved for Initialization module use (PEIM)
0xE2h	O	O	O	X	X	X	O	X	Initial memory found, configured, and installed correctly
0xE3h	O	O	O	X	X	X	O	O	Reserved for Initialization module use (PEIM)
Driver eXecution Environment (DXE) Core (not accompanied by a beep code)									
0xE4h	O	O	O	X	X	O	X	X	Entered EFI driver execution phase (DXE)
0xE5h	O	O	O	X	X	O	X	O	Started dispatching drivers
0xE6h	O	O	O	X	X	O	O	X	Started connecting drivers
DXE Drivers									
0xE7h	O	O	O	X	O	O	X	O	Waiting for user input
0xE8h	O	O	O	X	O	X	X	X	Checking password
0xE9h	O	O	O	X	O	X	X	O	Entering BIOS setup
0xEAh	O	O	O	X	O	X	O	X	Flash Update
0xEEh	O	O	O	X	O	O	O	X	Calling Int 19. One beep unless silent boot is enabled.
0xEFh	O	O	O	X	O	O	O	O	Unrecoverable boot failure
Runtime Phase / EFI Operating System Boot									
0xF4h	O	O	O	O	X	O	X	X	Entering Sleep state
0xF5h	O	O	O	O	X	O	X	O	Exiting Sleep state
0xF8h	O	O	O	O	O	X	X	X	OS has requested EFI to close boot services (ExitBootServices () Has been called)
0xF9h	O	O	O	O	O	X	X	O	OS has switched to virtual address mode (SetVirtualAddressMap () Has been called)
0xFAh	O	O	O	O	O	X	O	X	OS has requested the system to reset (ResetSystem () has been called)
Pre-EFI Initialization Module (PEIM) / Recovery									
0x30h	X	X	O	O	X	X	X	X	Crisis recovery initiated because of a user request

Appendix B: POST Code Diagnostic LED Decoder

Checkpoint	Diagnostic LED Decoder								Description
	O = On, X=Off								
	Upper Nibble				Lower Nibble				
	MSB							LSB	
LED	8h	4h	2h	1h	8h	4h	2h	1h	
	#7	#6	#5	#4	#3	#2	#1	#0	
0x31h	X	X	O	O	X	X	X	O	Crisis recovery initiated by software (corrupt flash)
0x34h	X	X	O	O	X	O	X	X	Loading crisis recovery capsule
0x35h	X	X	O	O	X	O	X	O	Handing off control to the crisis recovery capsule
0x3Fh	X	X	O	O	O	O	O	O	Unable to complete crisis recovery capsule
Memory Error Codes (Accompanied by a beep code)									
0xE8h	O	O	O	X	O	X	X	X	No Usable Memory Error: No memory in the system, or SPD bad so no memory could be detected
0xEBh	O	O	O	X	O	X	O	O	Memory Test Error: memory failed Hardware BIST.
0xEDh	O	O	O	X	O	O	X	O	Population Error: RDIMMs and UDIMMs cannot be mixed in the system
0xEEh	O	O	O	X	O	O	O	X	Mismatch Error: more than 2 Quad Ranked DIMMS in a channel.

Appendix C: POST Error Messages and Handling

Whenever possible, the BIOS outputs the current boot progress codes on the video screen. Progress codes are 32-bit quantities plus optional data. The 32-bit numbers include class, subclass, and operation information. The class and subclass fields point to the type of hardware being initialized. The operation field represents the specific initialization activity. Based on the data bit availability to display progress codes, a progress code can be customized to fit the data width. The higher the data bit, the higher the granularity of information that can be sent on the progress port. The progress codes may be reported by the system BIOS or option ROMs.

The Response section in the following table is divided into three types:

- **Minor:** The message displays on the screen or in the Error Manager screen. The system continues booting with a degraded state. The user may want to replace the erroneous unit. The setup POST error Pause setting does not have any effect with this error.
- **Major:** The message is displayed in the Error Manager screen and an error is logged to the SEL. The setup POST error Pause setting determines whether the system pauses to the Error Manager for this type of error where the user can take immediate corrective action or choose to continue booting.
- **Fatal:** The message displays in the Error Manager screen, an error is logged to the SEL, and the system cannot boot unless the error is resolved. The user must replace the faulty part and restart the system. The setup POST error Pause setting does not have any effect with this error.

Table 22. POST Error Messages and Handling

Error Code	Error Message	Response
0012	CMOS date / time not set	Major
0048	Password check failed	Major
0108	Keyboard component encountered a locked error.	Minor
0109	Keyboard component encountered a stuck key error.	Minor
0113	Fixed Media The SAS RAID firmware can not run properly. The user should attempt to reflash the firmware.	Major
0140	PCI component encountered a PERR error.	Major
0141	PCI resource conflict	Major
0146	PCI out of resources error	Major
0192	L3 cache size mismatch	Fatal
0194	CPUID, processor family are different	Fatal
0195	Front side bus mismatch	Major
0196	Processor Model mismatch	Major
0197	Processor speeds mismatched	Major
0198	Processor family is unsupported.	Major
019F	Processor and chipset stepping configuration is unsupported.	Major
5220	CMOS/NVRAM Configuration Cleared	Major
5221	Passwords cleared by jumper	Major
5224	Password clear Jumper is Set.	Major

Appendix C: POST Error Messages and Handling

Error Code	Error Message	Response
8180	Processor 01 BIOS does not support the current stepping for processor	Minor
8181	Processor 02 BIOS does not support the current stepping for processor	Minor
8190	Watchdog timer failed on last boot	Major
8198	Operating system boot watchdog timer expired on last boot	Major
8300	Baseboard management controller failed self-test	Major
84F2	Baseboard management controller failed to respond	Major
84F3	Baseboard management controller in update mode	Major
84F4	Sensor data record empty	Major
84FF	System event log full	Minor
8500	Memory component could not be configured in the selected RAS mode.	Major
8520	DIMM_A1 failed Self Test (BIST).	Major
8521	DIMM_A2 failed Self Test (BIST).	Major
8522	DIMM_A3 failed Self Test (BIST).	Major
8524	DIMM_B1 failed Self Test (BIST).	Major
8525	DIMM_B2 failed Self Test (BIST).	Major
8526	DIMM_B3 failed Self Test (BIST).	Major
8528	DIMM_C1 failed Self Test (BIST).	Major
8529	DIMM_C2 failed Self Test (BIST).	Major
852A	DIMM_C3 failed Self Test (BIST).	Major
852C	DIMM_D1 failed Self Test (BIST).	Major
852D	DIMM_D2 failed Self Test (BIST).	Major
852E	DIMM_D3 failed Self Test (BIST).	Major
8540	DIMM_A1 Disabled.	Major
8541	DIMM_A2 Disabled.	Major
8542	DIMM_A3 Disabled.	Major
8544	DIMM_B1 Disabled.	Major
8545	DIMM_B2 Disabled.	Major
8546	DIMM_B3 Disabled.	Major
8548	DIMM_C1 Disabled.	Major
8549	DIMM_C2 Disabled.	Major
854A	DIMM_C3 Disabled.	Major
854C	DIMM_D1 Disabled.	Major
854D	DIMM_D2 Disabled.	Major
854E	DIMM_D3 Disabled.	Major
8560	DIMM_A1 Component encountered a Serial Presence Detection (SPD) fail error.	Major
8561	DIMM_A2 Component encountered a Serial Presence Detection (SPD) fail error.	Major
8562	DIMM_A3 Component encountered a Serial Presence Detection (SPD) fail error.	Major
8564	DIMM_B1 Component encountered a Serial Presence Detection (SPD) fail error.	Major
8565	DIMM_B2 Component encountered a Serial Presence Detection (SPD) fail error.	Major
8566	DIMM_B3 Component encountered a Serial Presence Detection (SPD) fail error.	Major
8568	DIMM_C1 Component encountered a Serial Presence Detection (SPD) fail error.	Major
8569	DIMM_C2 Component encountered a Serial Presence Detection (SPD) fail error.	Major
856A	DIMM_C3 Component encountered a Serial Presence Detection (SPD) fail error.	Major
856C	DIMM_D1 Component encountered a Serial Presence Detection (SPD) fail error.	Major

Appendix C: POST Error Messages and Handling

Error Code	Error Message	Response
856D	DIMM_D2 Component encountered a Serial Presence Detection (SPD) fail error.	Major
856E	DIMM_D3 Component encountered a Serial Presence Detection (SPD) fail error.	Major
8580	DIMM_A1 Correctable ECC error encountered.	Minor/Major after 10
8581	DIMM_A2 Correctable ECC error encountered.	Minor/Major after 10
8582	DIMM_A3 Correctable ECC error encountered.	Minor/Major after 10
8584	DIMM_B1 Correctable ECC error encountered.	Minor/Major after 10
8585	DIMM_B2 Correctable ECC error encountered.	Minor/Major after 10
8586	DIMM_B3 Correctable ECC error encountered.	Minor/Major after 10
8588	DIMM_C1 Correctable ECC error encountered.	Minor/Major after 10
8589	DIMM_C2 Correctable ECC error encountered.	Minor/Major after 10
858A	DIMM_C3 Correctable ECC error encountered.	Minor/Major after 10
858C	DIMM_D1 Correctable ECC error encountered.	Minor/Major after 10
858D	DIMM_D2 Correctable ECC error encountered.	Minor/Major after 10
858E	DIMM_D3 Correctable ECC error encountered.	Minor/Major after 10
85A0	DIMM_A1 Uncorrectable ECC error encountered.	Major
85A1	DIMM_A2 Uncorrectable ECC error encountered.	Major
85A2	DIMM_A3 Uncorrectable ECC error encountered.	Major
85A4	DIMM_B1 Uncorrectable ECC error encountered.	Major
85A5	DIMM_B2 Uncorrectable ECC error encountered.	Major
85A6	DIMM_B3 Uncorrectable ECC error encountered.	Major
85A8	DIMM_C1 Uncorrectable ECC error encountered.	Major
85A9	DIMM_C2 Uncorrectable ECC error encountered.	Major
85AA	DIMM_C3 Uncorrectable ECC error encountered.	Major
85AC	DIMM_D1 Uncorrectable ECC error encountered.	Major
85AD	DIMM_D2 Uncorrectable ECC error encountered.	Major
85AE	DIMM_D3 Uncorrectable ECC error encountered.	Major
8604	Chipset Reclaim of non critical variables complete.	Minor
9000	Unspecified processor component has encountered a non specific error.	Major
9223	Keyboard component was not detected.	Minor
9226	Keyboard component encountered a controller error.	Minor
9243	Mouse component was not detected.	Minor
9246	Mouse component encountered a controller error.	Minor
9266	Local Console component encountered a controller error.	Minor
9268	Local Console component encountered an output error.	Minor
9269	Local Console component encountered a resource conflict error.	Minor
9286	Remote Console component encountered a controller error.	Minor
9287	Remote Console component encountered an input error.	Minor
9288	Remote Console component encountered an output error.	Minor
92A3	Serial port component was not detected	Major
92A9	Serial port component encountered a resource conflict error	Major
92C6	Serial Port controller error	Minor
92C7	Serial Port component encountered an input error.	Minor
92C8	Serial Port component encountered an output error.	Minor
94C6	LPC component encountered a controller error.	Minor

Appendix C: POST Error Messages and Handling

Error Code	Error Message	Response
94C9	LPC component encountered a resource conflict error.	Major
9506	ATA/ATPI component encountered a controller error.	Minor
95A6	PCI component encountered a controller error.	Minor
95A7	PCI component encountered a read error.	Minor
95A8	PCI component encountered a write error.	Minor
9609	Unspecified software component encountered a start error.	Minor
9641	PEI Core component encountered a load error.	Minor
9667	PEI module component encountered a illegal software state error.	Fatal
9687	DXE core component encountered a illegal software state error.	Fatal
96A7	DXE boot services driver component encountered a illegal software state error.	Fatal
96AB	DXE boot services driver component encountered invalid configuration.	Minor
96E7	SMM driver component encountered a illegal software state error.	Fatal
0xA000	TPM device not detected.	Minor
0xA001	TPM device missing or not responding.	Minor
0xA002	TPM device failure.	Minor
0xA003	TPM device failed self test.	Minor
0xA022	Processor component encountered a mismatch error.	Major
0xA027	Processor component encountered a low voltage error.	Minor
0xA028	Processor component encountered a high voltage error.	Minor
0xA421	PCI component encountered a SERR error.	Fatal
0xA500	ATA/ATPI ATA bus SMART not supported.	Minor
0xA501	ATA/ATPI ATA SMART is disabled.	Minor
0xA5A0	PCI Express component encountered a PERR error.	Minor
0xA5A1	PCI Express component encountered a SERR error.	Fatal
0xA5A4	PCI Express IBIST error.	Major
0xA6A0	DXE boot services driver Not enough memory available to shadow a legacy option ROM.	Minor

The following table lists POST error beep codes. Prior to system Video initialization, the BIOS uses these beep codes to inform users of error conditions. The beep code is followed by a user-visible code on POST Progress LEDs.

Table 23. POST Error Beep Codes

Beeps	Error Message	POST Progress Code	Description
3	Memory error		System halted because a fatal error related to the memory was detected

In the case of POST error(s) listed as Major, the BIOS enters the error manager and waits for the user to press an appropriate key before booting the operating system or entering the BIOS Setup.

The user can override this option by setting the POST Error Pause option as disabled on the BIOS setup Main screen. If this option is disabled, the system boots the operating system without user intervention. The default is disabled.

Glossary

Word / Acronym	Definition
ACA	Australian Communication Authority
ANSI	American National Standards Institute
BMC	Baseboard Management Controller
CMOS	Complementary Metal Oxide Silicon
D2D	DC-to-DC
EMP	Emergency Management Port
FP	Front Panel
FRB	Fault Resilient Boot
FRU	Field Replaceable Unit
LCD	Liquid Crystal Display
LPC	Low-Pin Count
MTBF	Mean Time Between Failure
MTTR	Mean Time to Repair
OTP	Over-temperature Protection
OVP	Over-voltage Protection
PFC	Power Factor Correction
PSU	Power Supply Unit
RI	Ring Indicate
SCA	Single Connector Attachment
SDR	Sensor Data Record
SE	Single-Ended
UART	Universal Asynchronous Receiver Transmitter
USB	Universal Serial Bus
VCCI	Voluntary Control Council for Interference

Reference Documents

See the following documents for additional information:

- Intel® Server Board S5500BC Technical Product Specification
- Intel® Server Board S5500BC Tested Hardware and Operating System List
- Intel® Server Board S5500BC / Intel® Server Chassis SC5650 / Intel® Server System SR1630BC Spares/Parts List and Configuration Guide
- Intel® S5500 Chipsets Server Board BIOS External Product Specification