

7 Install DIMM Memory Modules

DDR3 DIMM Memory Identification:

CAUTION: Observe normal ESD (ElectroStatic Discharge) procedures to avoid possible damage to system components.

This server board supports up to 6 DDR3-800/1066/1333 ECC RDIMM or 1066/1333 ECC UDIMM.

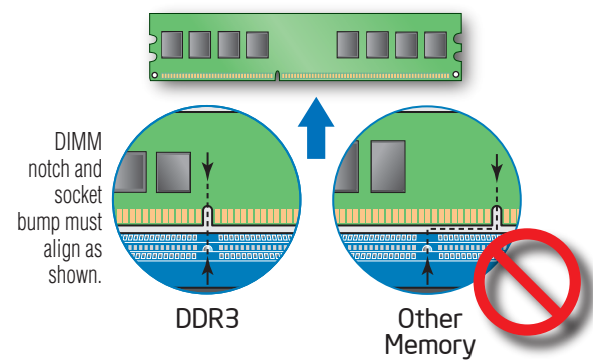

Memory Configurations and Population Order:

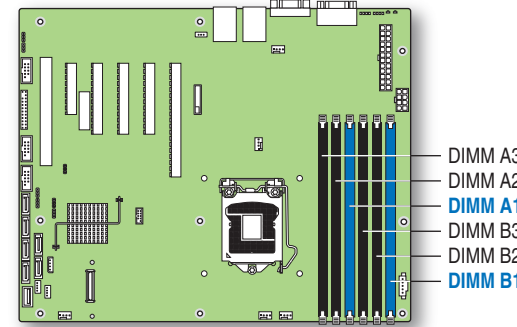

Memory Type: Minimum of one 1 GB, DDR3 800/1066/1333 MHz ECC RDIMM or 1066/1333 MHz ECC UDIMM.

Note: For additional memory configurations, see the User Guide on the Intel® Server Deployment Toolkit CD that accompanied your Intel® Server Board S3420GP, or go to: <http://www.intel.com/support/motherboards/server/s3420gp>

Memory sizing and configuration is supported only for qualified DIMMs approved by Intel®. For a list of supported memory, see the tested memory list at <http://serverconfigurator.intel.com/default.aspx>

To Install DIMMs:

CAUTION: Avoid touching contacts when handling or installing DIMMs.

- Open both DIMM socket levers.
- Note location of alignment notch.
- Insert DIMM making sure the connector edge of the DIMM aligns correctly with the slot.
- Push down firmly on the DIMM until it snaps into place and both levers close.
- IMPORTANT!** Visually check that each latch is fully closed and correctly engaged with each DIMM edge slot.

8 Make Server Board Power Connections

- Attach the CPU power connector.
- Attach the main power connector.

CAUTION: Note the location of the latch on each power cable connector and align it with the matching tab on each server board socket.

IMPORTANT NOTE: If you are using a non-Intel server chassis with an ATX power supply, see the documentation that came with your chassis for installation information.

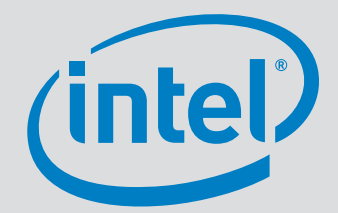
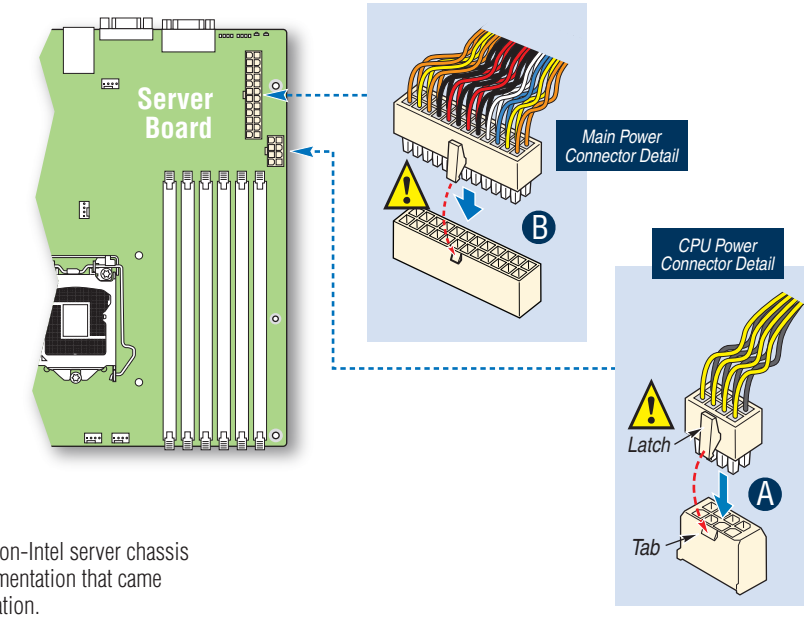

9 Install Optical Drive and Hard Drive(s)

See the documentation that came with your server chassis for drive installation.

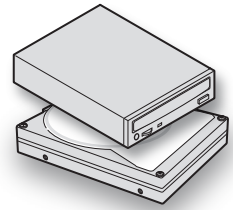

10 Connect Hard Drives/Optical Drive to Server Board

Connect SATA Data Cables to server board here.

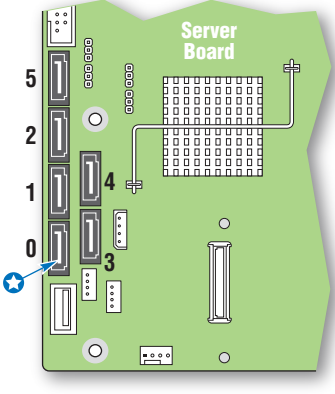
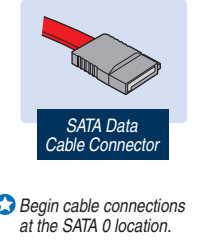

11 Attach Intrusion Switch Cable

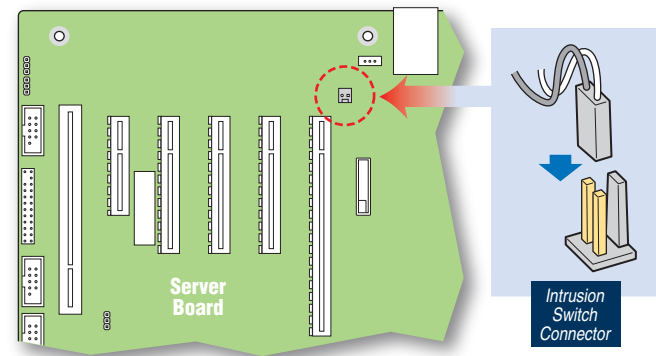

Note: For a non-Intel chassis, see your chassis documentation for intrusion switch requirements.

12 Attach Front Panel, Serial, and USB Connections

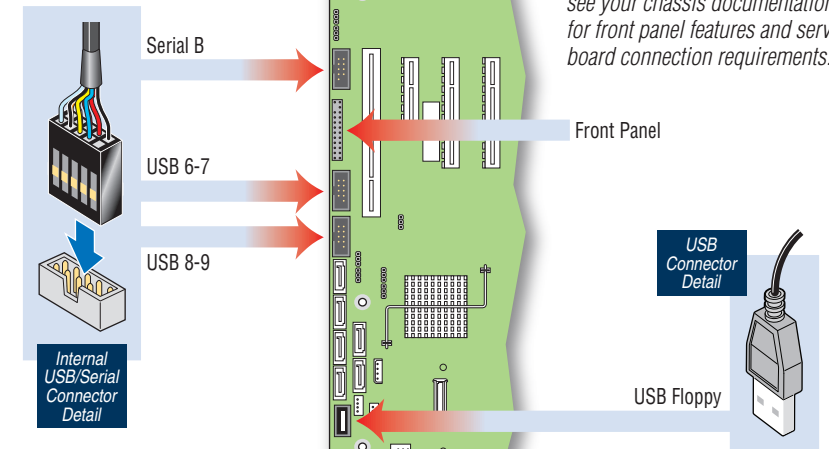

Note: For a non-Intel chassis, see your chassis documentation for front panel features and server board connection requirements.

13 Chassis Fan Connections

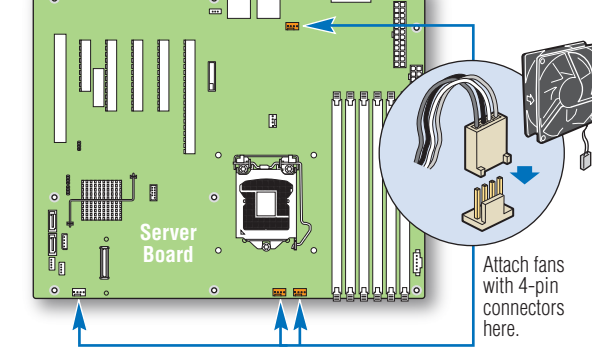

For a non-Intel server chassis, see the "Making Connections ... Quick Reference" section below, and the documentation accompanying your chassis for specific chassis fan connection requirements.

14 Install Add-in Card[s]

See the documentation that came with your server chassis for add-in card installation. For the Intel® Server Chassis SC5650UP, see the Quick Start User's Guide accompanying the chassis.

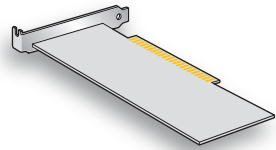

15 Finishing Up

Before installing your operating system, you must finish your chassis installation, make I/O connections and plug in AC power. See your chassis documentation for AC power and grounding requirements.

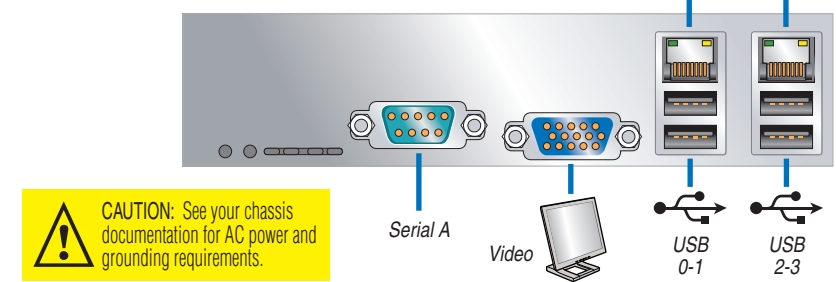

CAUTION: See your chassis documentation for AC power and grounding requirements.

16 Software • BIOS, Drivers, and Operating System Installation

- Confirm BIOS Version:** Look on the Server/System Management screen in the BIOS Setup Utility to determine the installed BIOS version. Compare this to the versions at: <http://www.intel.com/support/motherboards/server/s3420gp>. If new versions are available, update the BIOS on your server. See the User Guide on the Intel® Server Deployment Toolkit CD for update instructions.
- Configure your RAID Controller:** Use the instructions provided with the RAID controller.
- Install your Operating System:** Use the instructions provided with the RAID controller and with the operating system.
- Install Operating System Drivers:** With the operating system running, insert the Intel® Server Deployment Toolkit CD. If using a Microsoft Windows® operating system, the Intel® Deployment Assistant will autoun and allow you to select the appropriate drivers to install. On other operating systems, browse the CD folders to locate and install the driver files.

Common Problems and Solutions

For a list of hardware components that have been tested with this system, see: <http://www.intel.com/support/motherboards/server/s3420gp/>

- The system does not boot or show video at power-on.
 - Check that the +12V CPU power connector is plugged in. Without this cable, the processors will not have any power.
 - Only Intel® Xeon® processors 3400 series with 95 W and less Thermal Design Power (TDP) are supported on this server board. Previous generation Intel® Xeon® processors are not supported. Beep code 1-5-2-1 in a system means you do not have Intel® Xeon® processors 3400 sequence installed.
 - The system generates the memory error beep code and POST diagnostic LED message (0XE8-0XEE) that means some memory errors in early POST.
 - Remember, all DIMMs must be:
 - DDR3 800/1066/1333 MHz ECC Registered DIMM or 1066/1333 MHz ECC Unbuffered DIMM.
 - From the same manufacturer.
 - Installed beginning with DIMM A1.
- The system sometimes works, but is exhibiting erratic behavior.

Intel® Server Board S3420GP Component Layout

Note: Not all components, jumpers and connectors are described in this diagram. Refer to your Server Board User's Guide on the Intel® Server Deployment Toolkit CD for additional information.

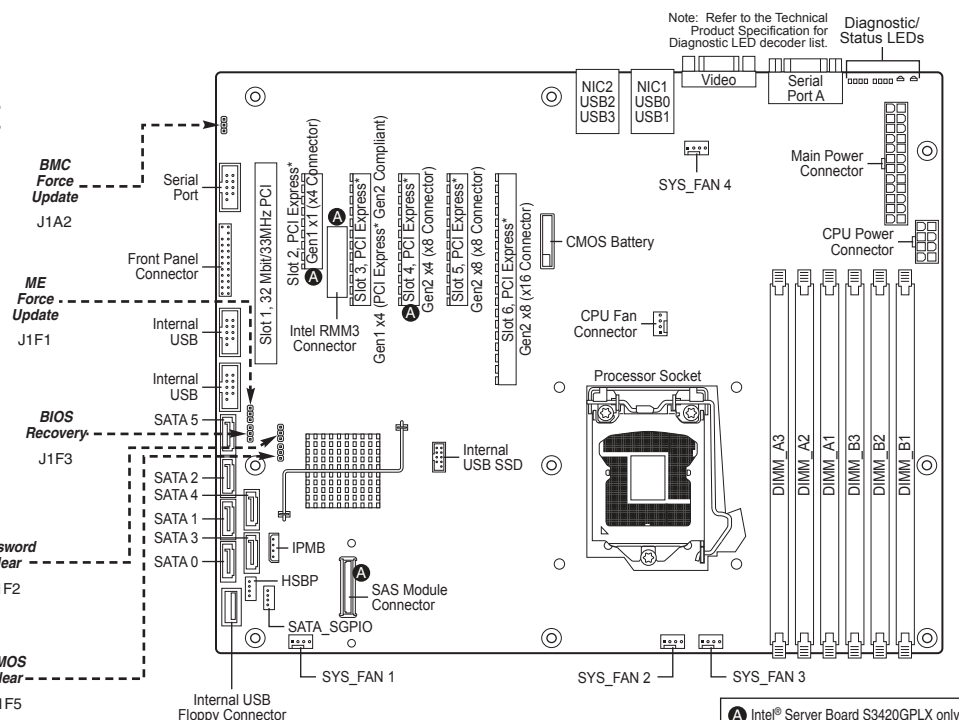

Accessories and Order Codes

ATX I/O Shield	AXXTIO
Intel® Remote Management Module 3	AXXRMM3
Intel® SAS Entry RAID Module	AXXASAMOD
SATA Slim-Line DVD	AXXSATDVD

Additional Reference documents available at: <http://www.intel.com/support/motherboards/server/s3420gp/>

A complete list of accessories and spares can be found at: <http://www.intel.com/support/motherboards/server/s3420gp> (search for the document titled "Spares and Configuration Guide".)

Available Documents

Document/Tool	Content
Technical Product Specification	In-depth technical information
Spares, Parts List, and Configuration Guide	Supported accessories and spares list
Server Configurator Tool	Tested peripherals and operating systems list Tested memory list Supported processors list
Software and Drivers	Up-to-date firmware, driver and utility information

Additional Reference documents available at: <http://www.intel.com/support/motherboards/server/s3420gp/>

Making Connections to the Server Board ... Quick Reference

Required Connections		Intel® Server Chassis SC5650UP
A. +12V CPU Power Connector		■
B. Main Power Connector		■
C. Front Panel Header		■

CPU/System Fan Connections		Intel® Server Chassis SC5650UP
D. System Fan 1 Header		■
E. System Fan 2 Header		■
F. System Fan 3 Header		■
G. System Fan 4 Header		■
H. CPU Fan Header		■

Optional Connections		Intel® Server Chassis SC5650UP
I. HSBP		■
J. USB 6-9		■
K. SATA Connectors		■
L. Serial B		■
M. Chassis Intrusion Header		■
N. IPMB		■
O. SATA SGPIO		■
P. Internal USB SSD		■
Q. SAS Module Header		■

Note: For a non-Intel Chassis, see your chassis documentation for server board connection information.

Note: Not all optional connections are shown in this diagram. Refer to your Server Board User's Guide, and your server chassis documentation for additional connection information.

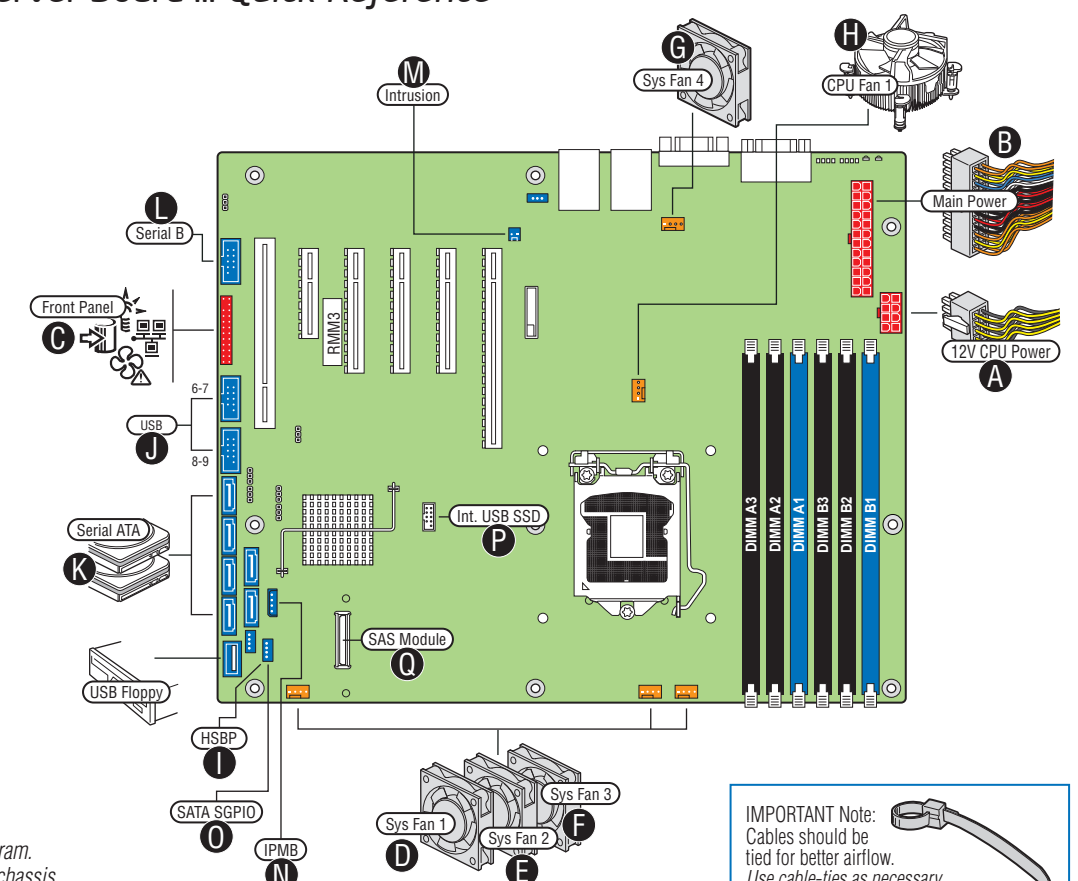

IMPORTANT Note: Cables should be tied for better airflow. Use cable-ties as necessary.