

G13B32-001

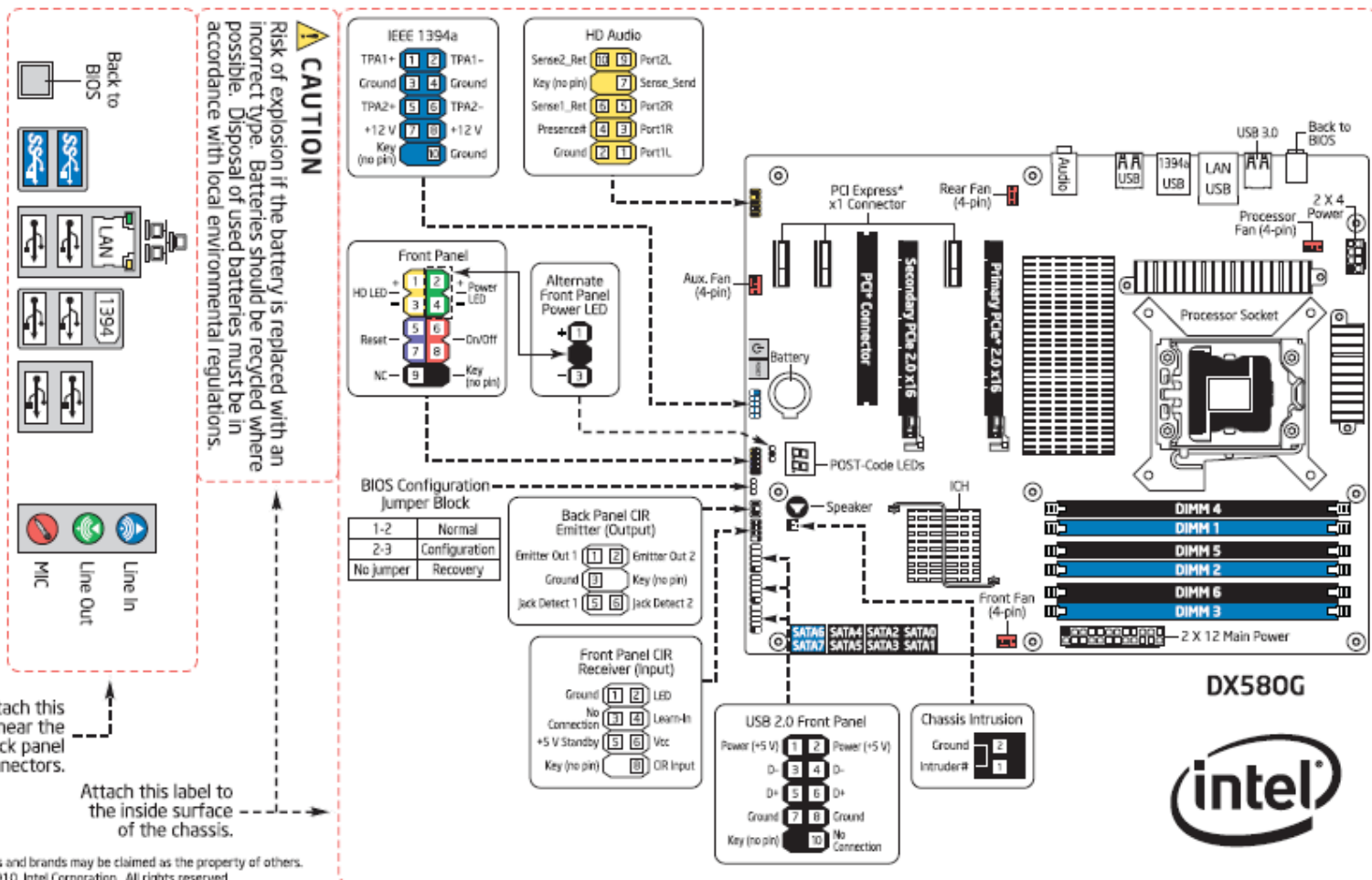

CAUTION

Risk of explosion if the battery is replaced with an incorrect type. Batteries should be recycled where possible. Disposal of used batteries must be in accordance with local environmental regulations.

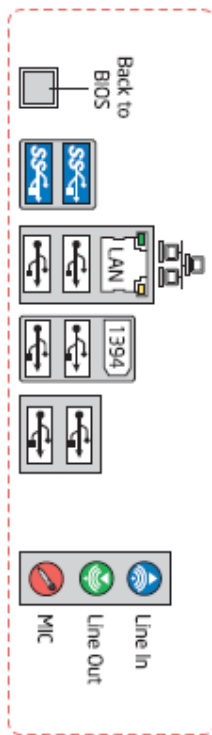

Attach this label near the back panel connectors.

Attach this label to the inside surface of the chassis.

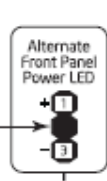
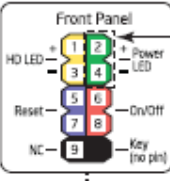
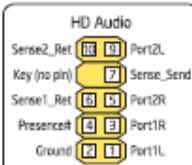
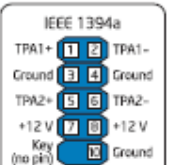

BIOS Configuration Jumper Block

1-2	Normal
2-3	Configuration
No Jumper	Recovery

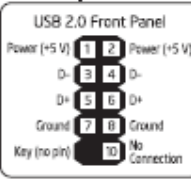
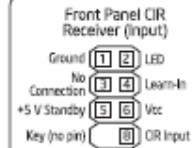
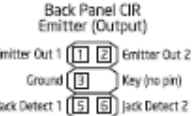

*Other names and brands may be claimed as the property of others. Copyright © 2010, Intel Corporation. All rights reserved.