

G13837-002

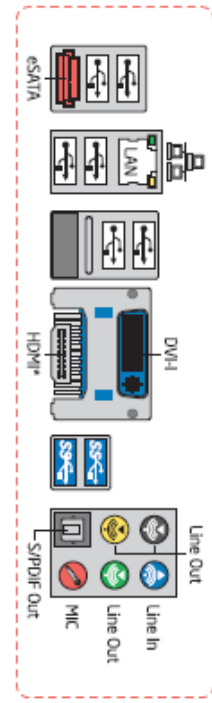

Attach this label near the back panel connectors.

Attach this label to the inside surface of the chassis.

**CAUTION**  
 Risk of explosion if the battery is replaced with an incorrect type. Batteries should be recycled where possible. Disposal of used batteries must be in accordance with local environmental regulations.

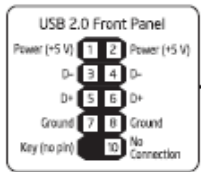
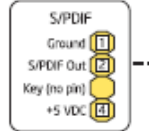
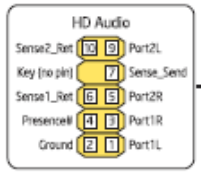
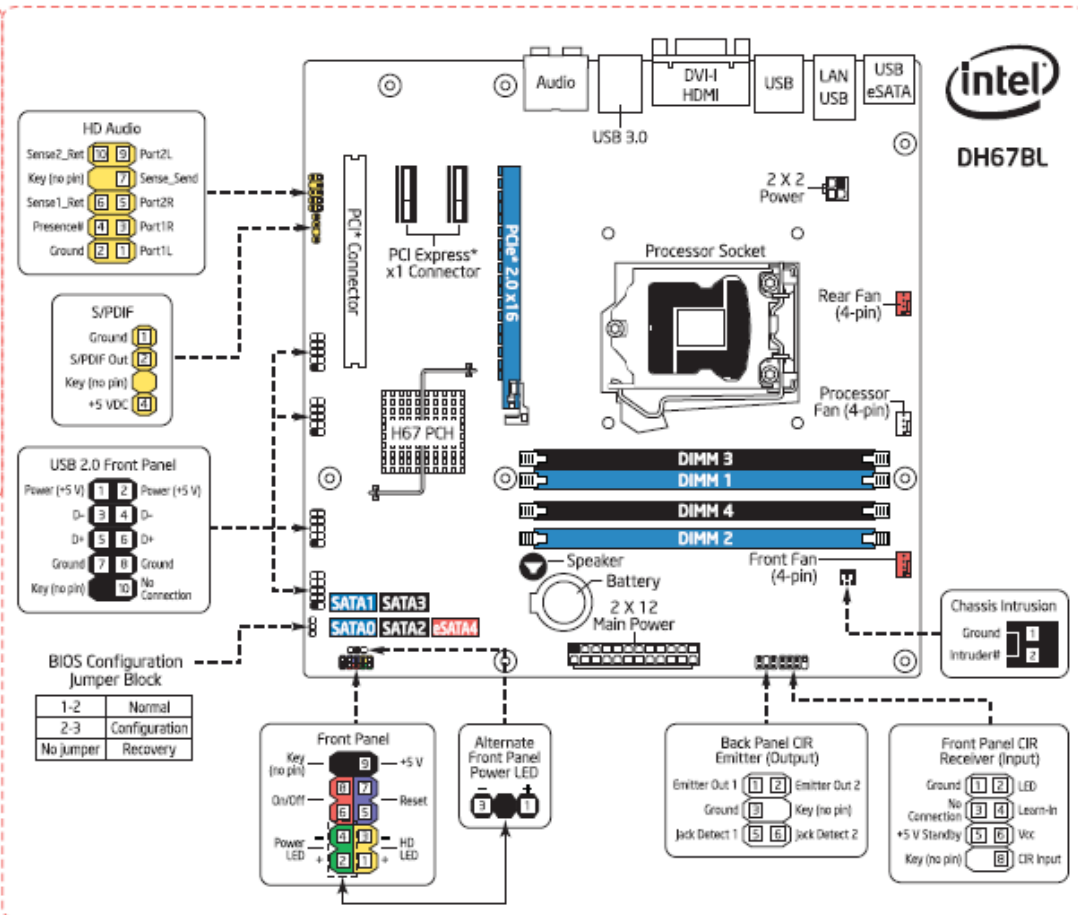

**BIOS Configuration Jumper Block**

1-2	Normal
2-3	Configuration
No jumper	Recovery

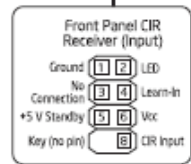
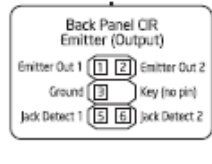
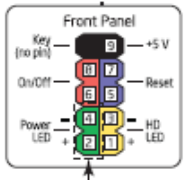

\*Other names and brands may be claimed as the property of others. Copyright © 2010, Intel Corporation. All rights reserved.