

Intel® Xeon® Processor 5500 Series

An Intelligent Approach
to IT Challenges



A Giant Leap for IT and Business Capabilities

In many organizations, IT infrastructure has begun to constrain business efficiency and growth. For the past decade, IT has rapidly added low-cost hardware to accommodate business growth. But with data centers now stretched to capacity in terms of power, cooling, and floor space, IT infrastructure is actually limiting IT from investing in innovation. IDC estimates that for every dollar IT spends on hardware to support new users and applications, they spend another 50 cents on power and cooling for existing hardware.¹



The Intel® Xeon® processor 5500 series can dramatically advance the efficiency of IT infrastructure and provide unmatched business capabilities.

As data centers reach the upper limits of their power and cooling capacity, efficiency has become the focus of extending the life of existing data centers and designing new ones. As part of these efforts, IT needs to refresh existing infrastructure with servers that deliver more performance and scalability, more efficiently. The Intel® Xeon® processor 5500^A series provides a foundation for IT management to refresh existing or design new data centers to achieve greater performance while using less energy and space, and dramatically reducing operating costs. This groundbreaking intelligent server technology features:

- **Intelligent Performance** that automatically optimizes performance to fit business and application requirements.
- **Automated Energy Efficiency** that scales energy usage to the workload to achieve optimal performance/watt and reduce operating costs.
- **Flexible virtualization** that offers best-in-class performance and manageability in virtualized environments to improve IT infrastructure and reduce costs.

New standard business servers, high-performance computing (HPC) systems, and workstations built with this new generation of Intel® Microarchitecture, codenamed Nehalem, offer an unprecedented opportunity to dramatically advance the efficiency of IT infrastructure and provide unmatched business capabilities.

Refreshing ROI

Research shows that upgrading to multi-core servers with higher performing, more efficient processors can accelerate data center ROI, saving on power and cooling, space, labor, and software licensing costs. By refreshing IT infrastructure with more energy-efficient systems, you gain capacity to grow and to increase IT performance. The cost savings from energy alone will pay for new servers in about eight months.²

With up to 9x the performance compared to installed single-core servers,³ up to 50 percent lower server idle power compared to the previous generation,⁴ and unique virtualization capabilities, Intel Microarchitecture Nehalem lets you deliver more business results from every clock cycle, every IT man-hour, every watt, and every inch of data center space. The lower TCO and groundbreaking performance of the Intel Xeon processor 5500 series offers the opportunity to transform the competitiveness of your business and the economics of your data center.

Performance That Adapts to Your Software Environment

Application performance is critical for day-to-day business operations, as well as creating new products and reaching new customers. But many data centers are now at capacity, and new data centers are expensive to build. By refreshing data center infrastructure with more efficient servers, you can deliver additional performance and scalability within the same energy and space footprint.

The Intel Xeon processor 5500 series, with Intel Microarchitecture Nehalem, brings intelligent performance to the most trusted server architecture. The Intel Xeon processor 5500 series is the world's most adaptable server platform, adjusting performance and power usage in real time to meet the exact requirements of your computing workloads, while allowing manual adjustment for IT control.

The Intel Xeon processor 5500 series brings together a number of innovative technologies to deliver intelligent performance:

- **Intel® Turbo Boost Technology**, together with Intel® Intelligent Power Technology, delivers performance on demand, letting processors operate above the rated frequency to speed specific workloads and reduce power consumption during low utilization periods.

- **Intel® Hyper-Threading Technology**[†] benefits from larger caches and massive memory bandwidth, delivering greater throughput and responsiveness for multi-threaded applications.
- **Intel® QuickPath Technology** and an integrated memory controller speed traffic between processors and I/O controllers for bandwidth-intensive applications, delivering up to 3.5x the bandwidth for technical computing⁵

The intelligent performance of the Intel Xeon processor 5500 series also gives IT fine-grained manual control to adapt to changing priorities or to meet service-level agreements (SLAs). For example, Intel Intelligent Power Technology enables policy-based control that allows processors to operate at optimal frequency and power. The operating systems can make this determination automatically, or administrators can designate which applications require high-frequency processing and which should be executed at lower frequencies to conserve power.⁶

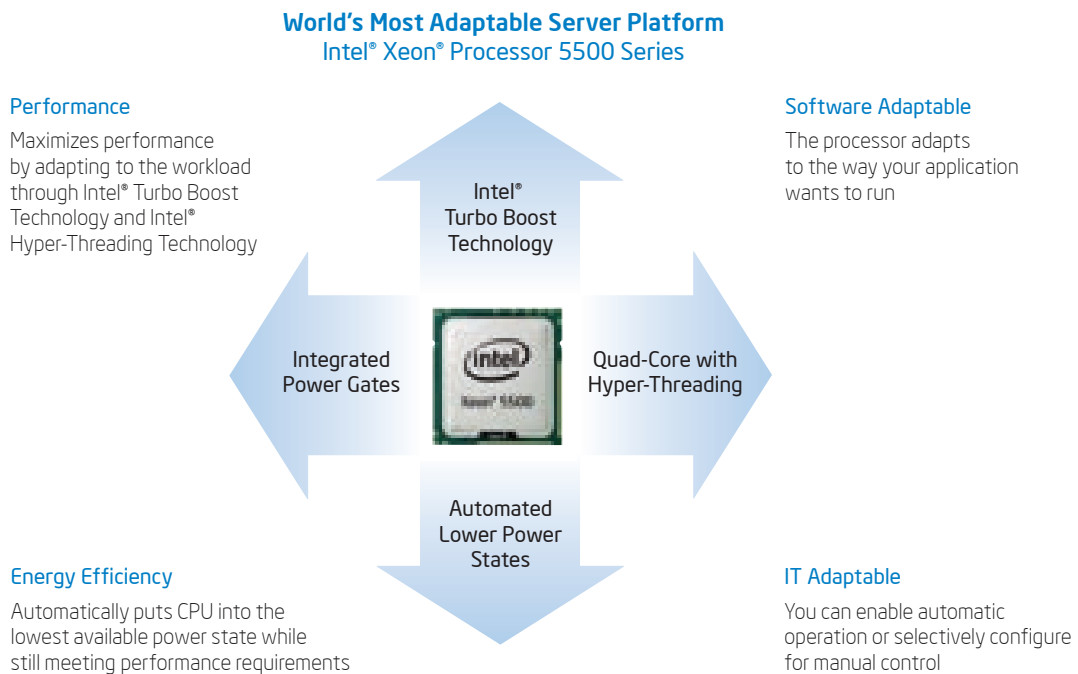

Automating Energy Efficiency

After decades of IT buildout, server sprawl is escalating system management costs and outstripping available data center space, power and cooling capabilities. In a recent survey, 42 percent of data center owners said they would exceed power capacity within the next 12-24 months, and 39 percent said they would exceed cooling capacity in the same timeframe.⁷ Energy efficiency is becoming a critical issue in the data center.

Intel Microarchitecture Nehalem helps lower energy costs with automated energy-efficiency features that deliver a 5x improvement in power management capabilities from the first Intel® quad-core server processors: 5x as many operating states, a 5x reduction in idle power, and 5x faster transitions to and from low-power states.⁸ Intel Intelligent Power Technology puts power management in all platform components: the processor, chipset, and memory, enabling operating systems to put processor power and memory into the lowest available states needed to support current workloads without compromising performance and allowing individual cores to be idled independent of the others. This combination of features enables the Intel Xeon processor 5500 series to deliver up to 50 percent lower server idle power.⁹

Intel Intelligent Power Technology makes power available for critical workloads while conserving power where there is less demand, delivering as much as 2.25x more performance in a similar power envelope¹⁰ and dramatically reducing idle power.¹¹

Maximizing Benefits from Virtualization

Intel is also building a better physical platform with unique hardware-assist features to enhance the virtual data center and help tame server sprawl. The Intel Xeon processor 5500 series, built on Intel Microarchitecture Nehalem, expands the benefits of virtualization with innovations that boost performance, increase consolidation ratios, and enable servers of different generations to be combined in the same virtualized server pool, improving virtual machine failover, load balancing, and disaster recovery capabilities.

The new Intel Microarchitecture Nehalem, with next-generation Intel® Virtualization Technology® (Intel® VT) enhances virtualization performance by up to 2.1x¹² and reduces roundtrip virtualization latency by up to 40 percent.¹³

- **Intel® Virtualization Technology** (Intel VT-x) continues to offer investment protection and infrastructure flexibility with multi-generation VM migration across the full range of 32-bit and 64-bit configurations, enabling bigger VM pools.
- **Intel® Virtualization Technology for Connectivity** (Intel® VT-c) provides hardware-assisted I/O that accelerates network performance and simplifies VM migration.
- **Intel® Virtualization Technology for Directed I/O** (Intel® VT-d) helps speed data movement and eliminates much of the performance overhead by giving designated VMs their own dedicated I/O devices, reducing the overhead of the VM migration in managing I/O traffic.



Intel® Microarchitecture Nehalem helps lower energy costs with automated energy-efficiency features that put processor power and memory into the lowest available states needed to support current workloads without compromising performance.

Standard Enterprise Server

Intel-based servers are the proven foundation of a dependable IT infrastructure. Now the Intel Xeon processor 5500 series offers a foundation to refresh aging IT infrastructure, overcoming server sprawl and accelerating data center ROI. Standard business servers based on the Intel Xeon processor 5500 series boost performance while saving on power and cooling requirements, delivering as much as 2.25x more performance in a similar power envelope¹⁴ and dramatically reducing idle power.¹⁵ In addition, hardware-assist features increase virtualization performance by up to 2.1x,¹⁶ giving IT the flexibility to make more efficient use of the data center.

Enterprise Servers that Deliver Unmatched Capability at a Lower Cost

With innovative technologies that boost performance, energy efficiency, and virtualization flexibility, two-processor platforms based on the Intel Xeon processor 5500 series make it easier to deliver more business services within existing data center facilities. Data center efficiency starts at the core – with energy-efficient processors and features that help you get the most out of each rack. With a unique combination of performance and energy-efficiency features plus flexible virtualization, the Intel Xeon processor 5500 series offers an effective antidote to data center sprawl and improves business competitiveness.

The combination of Intel Turbo Boost Technology and Intel Hyper-Threading Technology delivers optimal performance for each enterprise application, and Intel QuickPath Technology dramatically increases application performance and throughput for bandwidth-intensive applications. Greater per-server performance means that you can do more with fewer servers and potentially save significantly on operating costs.¹⁷

Intel Intelligent Power Technology works alongside these new performance features to deliver better performance with lower power consumption at all operating points, achieving the best available performance/watt. High-performance 95-watt, standard 80-watt and low-power 60-watt versions enable high-density deployments in both rack and blade form factors.

Intel VT with Intel FlexMigration and Intel FlexPriority also gives IT more choice in managing and allocating virtualized workloads across new and existing platforms. Intel Turbo Boost Technology plus hardware assists from Intel VT improves performance for applications running in virtual machines (VMs). Intel VT FlexMigration, in combination with virtualization management software, can help IT to conserve power, rebalance workloads and reduce energy consumption.

Refreshing Value for the Small and Medium Enterprise

The new Intel® Xeon® processor 5500 series is ideal for the small to medium-sized business looking for great performance, cost and energy-efficiency, and plenty of room to grow and virtualize in the future. Compared to installed single-core servers, these new intelligent processors enable up to 9x higher performance per server, up to 90 percent lower operating costs, and an estimated 8-month payback on investment.¹⁸

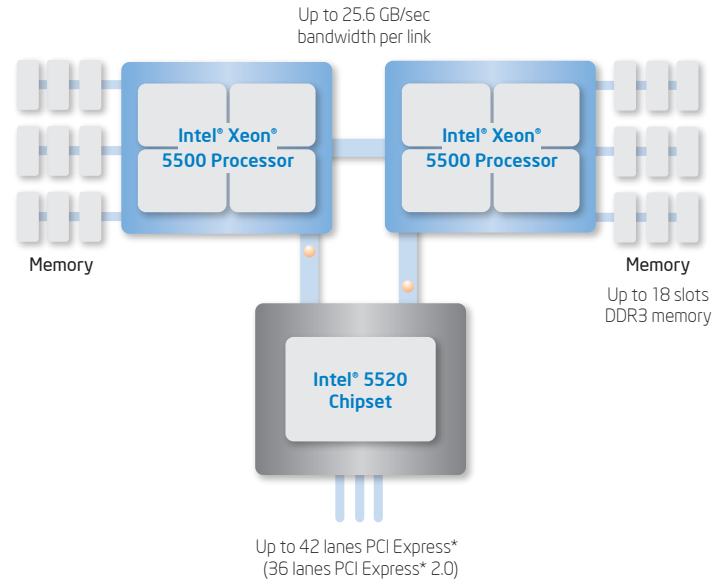

Key Benefits

- Up to 2.25x more performance for enterprise applications¹⁹
- Up to 50 percent lower system idle power²⁰
- Up to 18 slots DIMM with up to 144 GB DDR3 memory
- Up to 42 lanes PCI Express* (36 lanes PCI Express* 2.0)

Key Technologies

- Two Intel Xeon processors 5500 series
- Intel Turbo Boost Technology
- Intel Hyper-Threading Technology
- 8 MB shared L3 cache featuring Enhanced Smart Cache
- Intel QuickPath Technology
- Intel Intelligent Power Technology
- Intel Virtualization Technology

Key Usage

- Exceptional performance and efficiency for general-purpose business computing including:
 - E-mail servers
 - Web servers
 - File server
 - Business applications
- Flexible infrastructure for virtualization

High-Performance Computing

Two-processor servers based on the Intel Xeon processor 5500 series have up to eight computation engines, 16 threads per two-socket platform with Intel Hyper-Threading Technology, and as much as 3.5x more bandwidth than previous generations.²¹ With intelligent performance technology and a new high-bandwidth interconnect architecture, the Intel Xeon processor 5500 series delivers up to 4x greater performance for HPC applications than Intel dual-core processors.²²

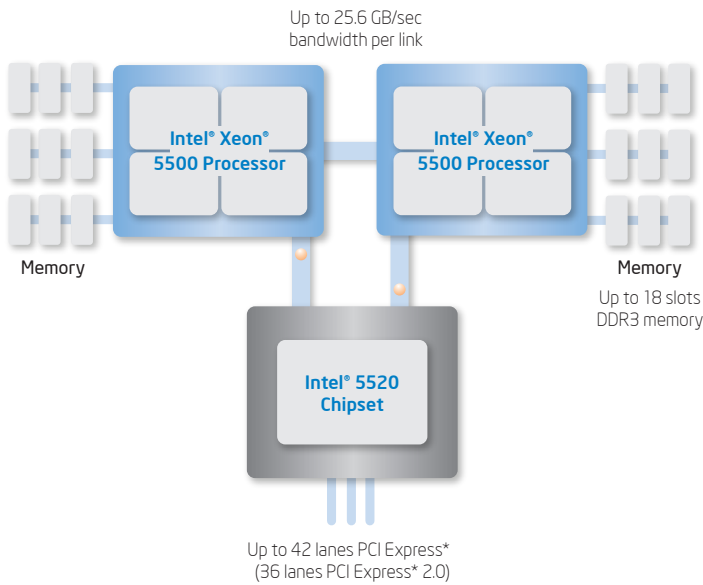

Key Benefits

- Up to 3.5x greater bandwidth for data-intensive applications²³
- Up to 18 slots DIMM with up to 144 GB DDR3 memory
- Up to 42 lanes PCI Express (36 lanes PCI Express 2.0)

Key Technologies

- Two Intel Xeon processors 5500 series
- Intel Turbo Boost Technology
- Intel Hyper-Threading Technology
- 8 MB shared L3 cache featuring Enhanced Smart Cache
- Intel QuickPath Technology
- Intel Intelligent Power Technology

Key Usage

- Bandwidth-intensive applications
- HPC clusters
- Multi-tasking user environments

Solving Big Problems Faster and More Efficiently

At Intel, we recognize that the need for performance increases all the time. That's why we provide platform-based solutions that maximize performance, improve throughput, and add new embedded technologies that give business, creative, and scientific professionals the tools to solve problems faster, process larger data sets, and meet bigger challenges. That's why 75 percent of the Supercomputing Top 500 results are on Intel processor-based platforms.²⁴

Two-processor technical compute server platforms based on the Intel Xeon processor 5500 series integrate intelligent performance, increased I/O bandwidth, and greater memory capacity. These processors feature Intel QuickPath Technology, a new, scalable, shared memory architecture that integrates a memory controller into each microprocessor and connects processors and other components with a new high-speed interconnect, proving the data bandwidth to keep each core running at capacity.

Intel Microarchitecture Nehalem boosts performance even further for critical workloads. Intel Turbo Boost Technology increases core frequency to improve execution speed as needed while Intelligent Power Technology conserves power on cores when there is less demand. For applications that lend themselves to parallel, multi-threaded execution, Intel Hyper-Threading Technology reduces computational latency, making optimal use of every cycle.

Technical compute platforms based on the Intel Xeon processor 5500 series support up to 16 simultaneous threads, with 32- and 64-bit processing capabilities, up to 144 GB of memory and a new, inclusive shared L3 cache that boosts performance while reducing traffic to the processor cores. These multi-core servers help maximize productivity, enhance visualization, and improve flexibility to help researchers, engineers, and developers achieve more in less time.

Speed and Efficiency for the Cloud

Flexibility and performance are paramount in the cloud data center, to maximize agility and uptime. Up to 4x greater performance than dual-core processors²⁵ plus advanced power management features enhance data center efficiency and help to dramatically reduce operating costs. Intel Virtualization Technology enables shared system resources for I/O, boosting performance and reducing inefficiencies through better isolation of workloads, and the ability to migrate running workloads across large pools of servers, while enabling high availability and real-time optimization of resource utilization.

Workstations

Two-processor workstation platforms based on the Intel Xeon processor 5500 series deliver as much as 2×26 more performance and flexibility to help users solve bigger problems, to build business advantage or to rapidly create, simulate, analyze, and visualize the success of new ideas. With two intelligent processors, these expert workstations provide powerful digital workbenches that enable users to maximize computing and graphics power to solve and visualize large-scale problems faster. Designed for expert workstation users, these next-generation digital workbenches integrate capabilities for flexibility and productivity, helping users get more done in less time.

Untouchable Workstation Performance

Optimized for multi-tasking environments, the Intel Xeon processor 5500 series features Intel Microarchitecture Nehalem for exceptional performance and data bandwidth, enabling users to quickly and efficiently transform complex data into actionable information. Intel Turbo Boost Technology increases performance by automatically increasing core frequencies and enabling faster speeds for specific threads and mega-tasking workloads. With support for up to 16 threads, Intel Hyper-Threading Technology delivers more performance for threaded applications such as rendering and digital content creation applications.

Intel's new workstation processors are optimized for higher performance on compute-intensive visualization workloads such as ray tracing. Intel QuickPath Technology, with high-speed point-to-point processor interconnects, plus larger caches and larger memory, provides 3.5x more bandwidth²⁷ for bandwidth-intensive applications such as CAD/CAE applications. The Intel Xeon processor 5500 series supports up to four PCIe 2 x16 Adapters, up to 72 lanes, and the expanded SSE4.2 instruction set includes enhanced branch prediction and loop stream detection to boost performance and cut energy consumption.

Intel workstation processors are designed to deliver performance and energy efficiency, enabling faster, quieter, cooler workstations. The Intel Xeon processor 5500 series features Intelligent Power Technology that automatically puts cores into the lowest available power states to meet the current workload while minimizing performance impact. Integrated Power Gates reduce energy costs by powering down unused cores during low-use periods.

With eight computational cores, up to 192 GB of memory,²⁸ and over 100 GFLOPS of compute performance, the Intel Xeon processor 5500 series delivers untouchable workstation performance, so you can render faster, analyze and display more data with higher fidelity, and speed visual comparisons.

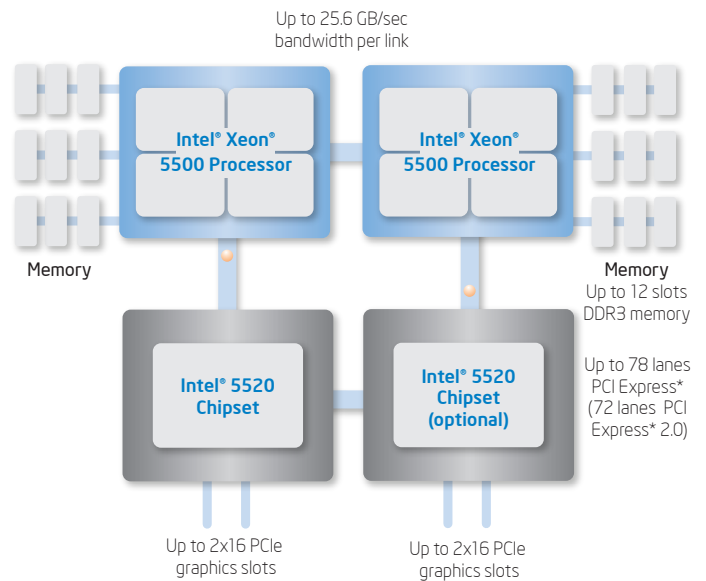

Key Benefits

- Up to 3.5x greater bandwidth for data-intensive applications²⁹
- Up to 12 DIMM slots and up to 192 GB DDR3 memory³⁰
- Up to 78 lanes PCI Express (72 lanes PCI Express 2.0)

Key Technologies

- Two Intel Xeon processors 5500 series
- Intel Turbo Boost Technology
- Intel Hyper-Threading Technology
- 8 MB shared L3 cache featuring Enhanced Smart Cache
- Intel QuickPath Technology
- Enhanced SSE4.2 instruction set
- Intel Intelligent Power Technology

Key Usage

- Work with larger, more detailed complex models and designs
- Run multiple applications at once with excellent system interactivity
- Speed up individual applications and threads
- Multi-tasking user environments
- Multi-media content creation
- Graphic-intensive applications
- Quieter, cooler, more power-efficient workstations

Exploring Intel® Microarchitecture Nehalem

The new generation of server processors from Intel provides a foundation for a fully adaptable IT environment. The architecture of these processors is designed with innovative features that adapt performance to software and business needs, help energy consumption for optimum performance and efficiency, and enable virtualization strategies that help your IT infrastructure adapt more quickly to your business needs.

Intel® Turbo Boost Technology

Intel Turbo Boost technology delivers performance when and where it's needed (see Figure 1). This technology allows processors to deliver higher speed execution on demand by using available power to run at a higher frequency.

Intel® Hyper-Threading Technology

Many server and workstation applications lend themselves to parallel, multi-threaded execution. Intel Hyper-Threading Technology enables simultaneous multi-threading within each processor core, up to two threads per core or eight threads per quad-core processor. Hyper-threading reduces computational latency, making optimal use of every clock cycle. For example, while one thread is waiting for a result or event, another thread is executing in that core, to maximize the work from each clock cycle.

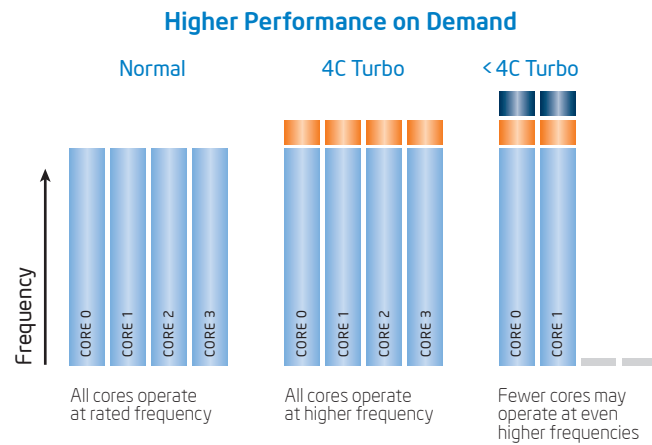

Figure 1. Intel® Turbo Boost Technology increases performance by increasing processor frequency and enabling faster speeds when conditions allow.

Intel® QuickPath Technology

To deliver top performance for bandwidth-intensive applications, the Intel Xeon processor 5500 series features Intel QuickPath Technology (see Figure 2). This new scalable, shared memory architecture delivers memory bandwidth leadership, and up to 3.5x the bandwidth of previous-generation processors.³¹

Intel QuickPath Technology is a platform architecture that provides high-speed (up to 25.6 GB/s), point-to-point connections between processors, and between processors and the I/O hub. Each processor has its own dedicated memory that it accesses directly through an Integrated Memory Controller. In cases where a processor needs to access the dedicated memory of another processor, it can do so through a high-speed Intel® QuickPath Interconnect (Intel® QPI) that links all the processors.

Intel Microarchitecture Nehalem complements the benefits of Intel QPI by enhancing Intel® Smart Cache with an inclusive shared L3 cache that boosts performance while reducing traffic to the processor cores.

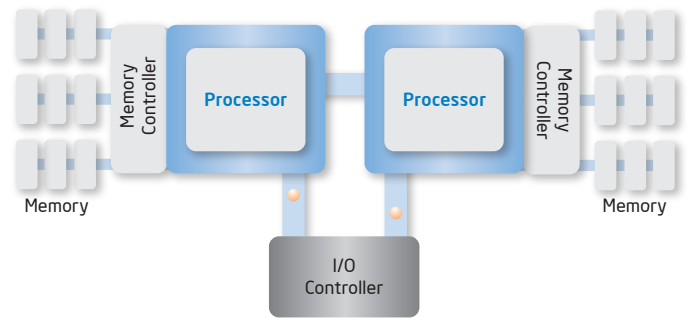

Figure 2. Intel® QuickPath Technology with dedicated per-processor memory and point-to-point connectivity.

Intel® Intelligent Power Technology

Within a single server, Intel Intelligent Power Technology minimizes power consumption when server components are not fully utilized.

- **Integrated Power Gates** (see Figure 3) allow individual idling cores to be reduced to near-zero power independent of other operating cores, reducing idle power consumption to 10 watts, versus 16 or 50 watts in prior-generations of Intel quad-core processors.³² This feature reduces server idle power consumption by up to 50 percent versus the previous generation of two-socket server processors.³³
- **Automated Low-Power States** automatically put processor and memory into the lowest available power states that will meet the requirements of the current workload (see Figure 4). Processors are enhanced with more and lower CPU power states, and the memory and I/O controllers have new power management features.

Automatic Operation or Manual Core Control

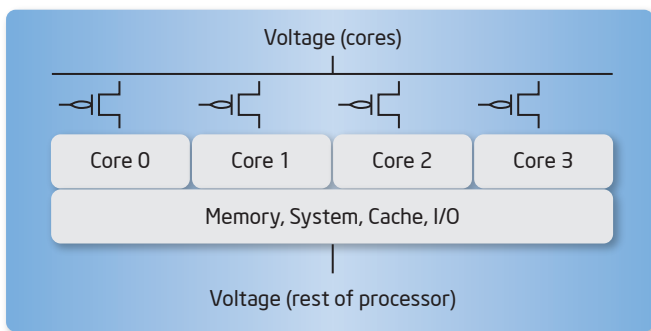

Figure 3. Integrated Power Gates enable idle cores to go to near-zero power independently.

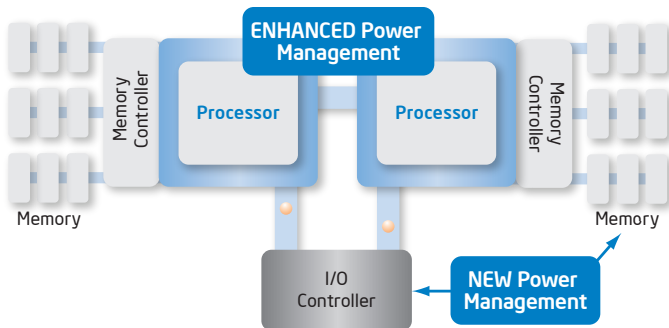

Figure 4. Automated Low-Power States adjusts system power consumption based on real-time load.

Intel® Virtualization Technology

Next-generation Intel Virtualization Technology enhances virtualization performance with new hardware-assist capabilities across all elements of your server:

- **Processor:** Improvements to Intel Virtualization Technology (Intel VT-x) provides hardware-assisted page-table management, allowing the guest OS more direct access to the hardware and reducing compute-intensive software translation from the VMM. Intel VT-x also includes Intel VT FlexMigration and Intel VT Flex-Priority, which are capabilities for flexible workload migration and performance optimization across the full range of 32-bit and 64-bit operating environments.
- **Chipset:** Intel Virtualization Technology for Directed I/O (Intel VT-d) helps speed data movement and eliminates much of the performance overhead by giving designated virtual machines their own dedicated I/O devices, thus reducing the overhead of the VMM in managing I/O traffic.
- **Network Adapter:** Intel Virtualization Technology for Connectivity (Intel VT-c) further enhances server I/O solutions by integrating extensive hardware assists into the I/O devices that are used to connect servers to the data center network, storage infrastructure and other external devices. By performing routing functions to and from virtual machines in dedicated network silicon, Intel VT-c speeds delivery and reduces the load on the VMM and server processors, providing up to 2x the throughput of non-hardware-assisted devices.³⁴

Intel® Xeon® Processor 5500 Series Overview

Features	Benefits
Intelligent Performance	<ul style="list-style-type: none"> Delivers up to 2.25x performance improvement within a power envelope similar to previous processors.³⁵
Intel® Turbo Boost Technology	<ul style="list-style-type: none"> Boosts performance for specific workloads by increasing processor frequency.
Intel® QuickPath Technology	<ul style="list-style-type: none"> Delivers up to 3.5x bandwidth improvement for data-intensive applications.³⁶
Intel® Hyper-Threading Technology ¹	<ul style="list-style-type: none"> Boosts performance for parallel, multi-threaded applications.
Larger memory capacity	<ul style="list-style-type: none"> Up to 144 GB of main memory supports higher performance for data-intensive applications.
Shared L3 cache	<ul style="list-style-type: none"> Boosts performance while reducing traffic to the processor cores.
Automated Energy Efficiency	<ul style="list-style-type: none"> Reduces server idle power consumption by up to 50 percent versus the previous generation of two-socket server processors.³⁷
Integrated Power Gates	<ul style="list-style-type: none"> Allows idling cores to be reduced to near-zero power independent of other cores.
Automated Low-Power States	<ul style="list-style-type: none"> Puts processor, memory and I/O controller into the lowest available power states that will meet the requirements of the current workload.
Flexible Virtualization	<ul style="list-style-type: none"> Enhances virtualization performance by up to 2.1x.³⁸
Processor	<ul style="list-style-type: none"> Hardware assists boost virtualization performance by allowing the OS more direct access to the hardware. Intel® VT FlexMigration enables seamless migration of running applications among current and future Intel processor-based servers. Intel® VT FlexPriority improves virtualization performance by allowing guest OSs to read and change task priorities without VMM intervention. Extended Page Tables (EPT) provide better performance by reducing the overhead caused by page-table utilization of virtual machines.
Chipset	<ul style="list-style-type: none"> Enables directly assignable I/O to Virtual Machines, helping speed data movement and enhancing performance.
Network	<ul style="list-style-type: none"> Delivers up to 2x throughput improvement³⁹ with extensive hardware assists to I/O devices.

What is the 5000 Sequence?

At Intel, our processor series numbers are intended to help clarify processor features, capabilities and intended usages. Intel offers four processor number sequences for server applications:

Intel® Xeon® processor 3000 sequence

One-processor servers for small business, entry, or first server, based on the Intel Xeon processor.

Intel® Xeon® processor 5000 sequence

Two-processor general-purpose, standard high-volume servers, HPC systems, and workstations based on Intel Xeon processors.

Intel® Xeon® processor 7000 sequence

Greater performance and scalability with 4- to 32-processor enterprise servers. These processors are designed for virtualization and data-demanding enterprise applications.

Intel® Itanium® processor 9000 sequence

Maximum scalability and RAS features for mission-critical workloads with 2- to 512-processor servers based on the Intel Itanium processor.

Intel Xeon Processor 5500 Series

The Intel Xeon processor 5500 series is available in a range of features to match different computing demands. All processors integrate Intel QuickPath Technology, Intel Intelligent Power Technology and Intel Virtualization Technology. Intel VT FlexMigration, Intel VT FlexPriority, and Intel® 64 architecture^s are standard on all SKUs. Higher frequency versions of the Intel Xeon processor 5500 series also support Demand-based Switching (DBS).

Processor Number ^A	CPU Frequency	Intel® Turbo Boost Technology	Intel® HT Technology	L3 Cache	Number of Cores	Power	Intel® QPI Link Speed	DDR3 Memory
Intel® Xeon® Processor W5580	3.20 GHz	▪	▪	8 MB	4	130 W	6.4 GT/s ^a	1333, 1066, 800
Intel® Xeon® Processor X5570	2.93 GHz	▪	▪	8 MB	4	95 W	6.4 GT/s	1333, 1066, 800
Intel® Xeon® Processor X5560	2.80 GHz	▪	▪	8 MB	4	95 W	6.4 GT/s	1333, 1066, 800
Intel® Xeon® Processor X5550	2.66 GHz	▪	▪	8 MB	4	95 W	6.4 GT/s	1333, 1066, 800
Intel® Xeon® Processor E5540	2.53 GHz	▪	▪	8 MB	4	80 W	5.86 GT/s	1066, 800
Intel® Xeon® Processor E5530	2.40 GHz	▪	▪	8 MB	4	80 W	5.86 GT/s	1066, 800
Intel® Xeon® Processor L5520	2.26 GHz	▪	▪	8 MB	4	60 W	5.86 GT/s	1066, 800
Intel® Xeon® Processor E5520	2.26 GHz	▪	▪	8 MB	4	80 W	5.86 GT/s	1066, 800
Intel® Xeon® Processor L5506	2.13 GHz			4 MB	4	60 W	4.8 GT/s	800
Intel® Xeon® Processor E5506	2.13 GHz			4 MB	4	80 W	4.8 GT/s	800
Intel® Xeon® Processor E5504	2.00 GHz			4 MB	4	80 W	4.8 GT/s	800
Intel® Xeon® Processor E5502	1.86 GHz			4 MB	2	80 W	4.8 GT/s	800

^a GT/s = giga-transfers/second

Systems Designed for Your Needs

Standard, Enterprise Servers: Intel® 5520 and 5500 Chipset

Server and workstation platforms based on the Intel® 5520 and 5500 Chipset, combined with the Intel Xeon processor 5500 series, drive breakthrough performance and state-of-the-art technology to performance and mainstream server platforms.

The Intel 5520 Chipset supports the Intel Xeon processor 5500 series at 6.4 GT/s, 5.86 GT/s and 4.8 GT/s speeds via the Intel QuickPath Interconnect. Additionally, this chipset delivers support for 36 lanes of PCI Express 2.0 I/O, Intel VT-c and Intel VT-d enhancements for virtualization OS, Intel® Dynamic Power Node Manager system management, and support for Intel® ICH10, ICH10R and Intel® 6700PXH 64-bit PCI Hub.

The Intel 5500 Chipset supports the Intel Xeon processor 5500 series at 6.4 GT/s, 5.86 GT/s and 4.8 GT/s speeds via the Intel QuickPath Interconnect. Additionally, this chipset delivers support for 24 lanes of PCI Express 2.0 I/O, Intel VT-c and Intel VT-d enhancements for virtualization OS, Intel Dynamic Power Node Manager system management, and support for Intel ICH10, ICH10R and Intel 6700PXH 64-bit PCI Hub.

High-Performance Computing Systems and Workstations: Intel 5520 Chipset in Single or Dual I/O Hub (IOH) Configuration

The Intel 5520 chipset improves data movement across Intel Xeon processor 5500 series-based workstations and HPC systems by increasing interconnect bandwidth, optimizing system bandwidth, increasing memory capacity, and improving network traffic processing while reducing I/O latency.

These platform advancements help to match the improved performance of the Intel Xeon processor 5500 series and include:

- Point-to-point connections via the Intel QuickPath Interconnect at 4.8, 5.86 and 6.4 GT/s speeds
- Dual IOH configuration for higher I/O connectivity, up to 72 lanes for PCI Express 2.0
- Multiple x16 or x8 PCI Express 2.0 graphics card support
- Intel VT-c and Intel VT-d virtualization technology enhancements
- Intel Dynamic Power Node Manager system management support
- Intel ICH10 and ICH10R
- Intel 6700PXH 64-bit PCI Hub

Learn More

For more information on the Intel Xeon processor 5500 series, visit www.intel.com/xeon.

For more information about Intel Microarchitecture Nehalem, visit www.intel.com/technology/architecture-silicon/next-gen.

⁴ Intel processor numbers are not a measure of performance. Processor numbers differentiate features within each processor family, not across different processor families. See www.intel.com/products/processor_number for details.

¹ Hyper-Threading Technology requires a computer system with a processor supporting Hyper-Threading Technology and an HT Technology enabled chipset, BIOS and operating system. Performance will vary depending on the specific hardware and software you use. See www.intel.com/info/hyperthreading/ for more information including details on which processors support HT Technology.

² Intel® Virtualization Technology requires a computer system with an enabled Intel® processor, BIOS, virtual machine monitor (VMM) and, for some uses, certain platform software enabled for it. Functionality, performance or other benefits will vary depending on hardware and software configurations and may require a BIOS update. Software applications may not be compatible with all operating systems. Please check with your application vendor.

³ 64-bit computing on Intel architecture requires a computer system with a processor, chipset, BIOS, operating system, device drivers and applications enabled for Intel® 64 architecture. Processors will not operate (including 32-bit operation) without an Intel 64 architecture-enabled BIOS. Performance will vary depending on your hardware and software configurations. Consult with your system vendor for more information.

¹ Source: IDC Document: Virtualization and Multicore Innovations Disrupt the Worldwide Server Market. Document number: 206035. Publish date: March 2007.

² Source: Intel. March 2009. Compares replacing nine four-year-old single-core Intel® Xeon® processor 3.8GHz with 2M cache-based servers with one new Intel Xeon processor X5570-based server. Results have been estimated based on internal Intel analysis and are provided for information purposes only.

³ Source: Intel estimates as of Nov 2008. Performance comparison using SPECjbb2005 bops (business operations per second). Results have been estimated based on internal Intel analysis and are provided for informational purposes only.

⁴ Intel internal measurements of 221W at idle with Supermicro 2xE5450 (3.0GHz 80W) processors, 8x2GB 667MHz FB DIMMs, 1x700W PSU, 1x320GB SATA hard drive vs. 111W at idle with Supermicro software development platform with 2xE5540 (2.53GHz Nehalem 80W) processors, 6x2GB DDR3-1066 RDIMMs, 1x800W PSU, 1x150GB 10k SATA hard drive. Both systems were running Windows 2008 with USB suspend select enabled and maximum power savings mode for PCIe link state power management. Measurements as of Feb 2009.

⁵ Intel internal measurement. (Feb 2009) Stream-Triad benchmark. Red Hat Enterprise Linux Server 5.3. Intel® Xeon® processor E5472, 3.0 GHz, 2x6MB L2 cache, 1600MHz system bus, 16GB memory (8x2GB FB DDR2-800) vs Intel® Xeon® processor X5570, 2.93 GHz, 8MB L3 cache, 6.4QPI, 24GB memory (6x4GB DDR3-1333).

⁶ Intel® Turbo Boost Technology requires a Platform with a processor with Intel Turbo Boost Technology capability. Intel Turbo Boost Technology performance varies depending on hardware, software and overall system configuration. Check with your platform manufacturer on whether your system delivers Intel Turbo Boost Technology. For more information, see www.intel.com/technology/turboboost.

⁷ Source: Infoworld, March 26, 2008.

⁸ Xeon® 5300 series data based on Xeon® X5365 SKU (B-3 stepping), Xeon® 5400 series based on Xeon® X5470 (E-0 stepping), and Xeon® 5500 based on Xeon® W5580 (D-0 stepping). Number of operating states includes all frequency operating points, including Turbo Boost and base frequency. Idle power based on C6 idle power for Xeon® 5500, and C1E for Xeon® 5300 and 5400 SKUs. C6 also requires OS support and may vary by SKU. Faster transitions based on Package C1E exit transition latency and PLL lock time for p-state transitions.

⁹ Intel internal measurements of 221W at idle with Supermicro 2xE5450 (3.0GHz 80W) processors, 8x2GB 667MHz FB DIMMs, 1x700W PSU, 1x320GB SATA hard drive vs. 111W at idle with Supermicro software development platform with 2xE5540 (2.53GHz Nehalem 80W) processors, 6x2GB DDR3-1066 RDIMMs, 1x800W PSU, 1x150GB 10k SATA hard drive. Both systems were running Windows 2008 with USB suspend select enabled and maximum power savings mode for PCIe link state power management. Measurements as of Feb 2009.

¹⁰ Compared to Xeon 5400 series. Claim supported by multiple performance results including an OLTP database benchmark and a bandwidth intensive scientific computing benchmark (SPECfp_rate_base2006). Intel internal measurement (Feb 2009).

¹¹ Intel internal measurements of 221W at idle with Supermicro 2xE5450 (3.0GHz 80W) processors, 8x2GB 667MHz FB DIMMs, 1x700W PSU, 1x320GB SATA hard drive vs. 111W at idle with Supermicro software development platform with 2xE5540 (2.53GHz Nehalem 80W) processors, 6x2GB DDR3-1066 RDIMMs, 1x800W PSU, 1x150GB 10k SATA hard drive. Both systems were running Windows 2008 with USB suspend select enabled and maximum power savings mode for PCIe link state power management. Measurements as of Feb 2009.

¹² Performance results on VMmark benchmark. Xeon X5470 data based on published results. Xeon X5570 Intel internal measurement. (Feb 2009): HP ProLiant ML370 G5 server platform with Intel Xeon processors X5470 3.33GHz, 2x6MB L2 cache, 1333MHz FSB, 48GB memory, VMware ESX V3.5.0 Update 3 Published at 9.15@ 7 titles vs Intel® Xeon® processor X5570, 2.93 GHz, 8MB L3 cache, 6.4QPI, 72GB memory (18x4GB DDR3-800), VMware ESX Build 140815. Performance measured at 19.51@ 13 titles.

¹³ Source: Intel internal measurements. Intel Xeon processor 5500 series (Nehalem) vs. Intel® Xeon® processor 5400 series.

¹⁴ Compared to 5400 series claim supported by multiple performance results including an OLTP database benchmark and a bandwidth intensive scientific computing benchmark (SPECfp_rate_base2006). Intel internal measurement (Feb 2009).

¹⁵ Intel internal measurements of 221W at idle with Supermicro 2xE5450 (3.0GHz 80W) processors, 8x2GB 667MHz FB DIMMs, 1x700W PSU, 1x320GB SATA hard drive vs. 111W at idle with Supermicro software development platform with 2xE5540 (2.53GHz Nehalem 80W) processors, 6x2GB DDR3-1066 RDIMMs, 1x800W PSU, 1x150GB 10k SATA hard drive. Both systems were running Windows 2008 with USB suspend select enabled and maximum power savings mode for PCIe link state power management. Measurements as of Feb 2009.

¹⁶ Performance results on VMmark benchmark. Xeon X5470 data based on published results. Xeon X5570 Intel internal measurement. (Feb 2009): HP ProLiant ML370 G5 server platform with Intel Xeon processors X5470 3.33GHz, 2x6MB L2 cache, 1333MHz FSB, 48GB memory, VMware ESX V3.5.0 Update 3 Published at 9.15@ 7 titles vs Intel® Xeon® processor X5570, 2.93 GHz, 8MB L3 cache, 6.4QPI, 72GB memory (18x4GB DDR3-800), VMware ESX Build 140815. Performance measured at 19.51@ 13 titles.

¹⁷ Source: Intel internal measurements 2005 – 2009 comparing Intel Xeon single core (3.8GHz w/ 2M cache) 382W power under load to Intel Xeon 5500 series (2.93GHz), 315W power under load. Performance comparison using SPECjbb2005 BOPS (business operations per second), 8 month payback is an Intel estimate based on comparing the cost savings achieved in 9:1 server consolidation from both power/cooling and OS licensing versus the estimated cost of purchasing a new server featuring Intel Xeon processor 5500 series. Results have been estimated based on internal Intel analysis and are provided for informational purposes only. Any difference in system hardware or software design or configuration may affect actual performance.

¹⁸ Source: Intel. March 2009. Compares replacing nine four-year-old single-core Intel® Xeon® processor 3.8GHz with 2M cache-based servers with one new Intel Xeon processor X5570-based server. Results have been estimated based on internal Intel analysis and are provided for information purposes only.

¹⁹ Compared to Xeon 5400 series claim supported by multiple performance results including an OLTP database benchmark and a bandwidth intensive scientific computing benchmark (SPECfp_rate_base2006). Intel internal measurement (Feb 2009).

²⁰ Intel internal measurements of 221W at idle with Supermicro 2xE5450 (3.0GHz 80W) processors, 8x2GB 667MHz FB DIMMs, 1x700W PSU, 1x320GB SATA hard drive vs. 111W at idle with Supermicro software development platform with 2xE5540 (2.53GHz Nehalem 80W) processors, 6x2GB DDR3-1066 RDIMMs, 1x800W PSU, 1x150GB 10k SATA hard drive. Both systems were running Windows 2008 with USB suspend select enabled and maximum power savings mode for PCIe link state power management. Measurements as of Feb 2009.

²¹ Intel internal measurement. (Feb 2009) Stream-Triad benchmark. Red Hat Enterprise Linux Server 5.3. Intel® Xeon® processor E5472, 3.0 GHz, 2x6MB L2 cache, 1600MHz system bus, 16GB memory (8x2GB FB DDR2-800) vs Intel® Xeon® processor X5570, 2.93 GHz, 8MB L3 cache, 6.4QPI, 24GB memory (6x4GB DDR3-1333).

²² Up to 4.0x performance compared to Xeon 5100 series claim supported by using performance results on SPECint_rate_base2006 and SPECfp_rate_base2006. Average gain of two results was used. Xeon 5160 data based on published results. Xeon X5570 based on Intel internal measurement (Feb 2009).

²³ Intel internal measurement. (Feb 2009) Stream-Triad benchmark. Red Hat Enterprise Linux Server 5.3. Intel® Xeon® processor E5472, 3.0 GHz, 2x6MB L2 cache, 1600MHz system bus, 16GB memory (8x2GB FB DDR2-800) vs Intel® Xeon® processor X5570, 2.93 GHz, 8MB L3 cache, 6.4QPI, 24GB memory (6x4GB DDR3-1333).

²⁴ Source: Top500.org.

²⁵ Up to 4.0x performance compared to Xeon 5100 series claim supported by using performance results on SPECint_rate_base2006 and SPECfp_rate_base2006. Average gain of two results was used. Xeon 5160 data based on published results. Xeon X5570 based on Intel internal measurement. (Feb 2009).

²⁶ Up to 2x performance compared to Xeon 5400 series claim supported by multiple performance results including a ray tracing benchmark and a bandwidth intensive scientific computing benchmark (SPECfp_rate_base2006). Intel internal measurement. (Feb 2009).

²⁷ Intel internal measurement. (Feb 2009) Stream-Triad benchmark. Red Hat Enterprise Linux Server 5.3. Intel® Xeon® processor E5472, 3.0 GHz, 2x6MB L2 cache, 1600MHz system bus, 16GB memory (8x2GB FB DDR2-800) vs Intel® Xeon® processor X5570, 2.93 GHz, 8MB L3 cache, 6.4QPI, 24GB memory (6x4GB DDR3-1333).

²⁸ With 16GB DIMMS. Supports up to 96GB with 8GB DIMMS under current design.

²⁹ Intel internal measurement. (Feb 2009) Stream-Triad benchmark. Red Hat Enterprise Linux Server 5.3. Intel® Xeon® processor E5472, 3.0 GHz, 2x6MB L2 cache, 1600MHz system bus, 16GB memory (8x2GB FB DDR2-800) vs Intel® Xeon® processor X5570, 2.93 GHz, 8MB L3 cache, 6.4QPI, 24GB memory (6x4GB DDR3-1333).

³⁰ With 16GB DIMMS. Supports up to 96GB with 8GB DIMMS under current design.

³¹ Intel internal measurement. (Feb 2009) Stream-Triad benchmark. Red Hat Enterprise Linux Server 5.3. Intel® Xeon® processor E5472, 3.0 GHz, 2x6MB L2 cache, 1600MHz system bus, 16GB memory (8x2GB FB DDR2-800) vs Intel® Xeon® processor X5570, 2.93 GHz, 8MB L3 cache, 6.4QPI, 24GB memory (6x4GB DDR3-1333).

³² Depending on processor SKU.

³³ Intel internal measurements of 221W at idle with Supermicro 2xE5450 (3.0GHz 80W) processors, 8x2GB 667MHz FB DIMMs, 1x700W PSU, 1x320GB SATA hard drive vs. 111W at idle with Supermicro software development platform with 2xE5540 (2.53GHz Nehalem 80W) processors, 6x2GB DDR3-1066 RDIMMs, 1x800W PSU, 1x150GB 10k SATA hard drive. Both systems were running Windows 2008 with USB suspend select enabled and maximum power savings mode for PCIe link state power management. Measurements as of Feb 2009.

³⁴ Intel internal measurement. (April 2008) Ixia® IxChariot® 6.4 benchmark. VMware® ESX® v3.5U1. Intel® Xeon® processor E5355, 2.66 GHz, 8MB L2 cache, 1333MHz system bus, 8GB memory (8x1GB FB DIMM 667MHz).

³⁵ Compared to Xeon 5400 series claim supported by multiple performance results including an OLTP database benchmark and a bandwidth intensive scientific computing benchmark (SPECfp_rate_base2006). Intel internal measurement (Feb 2009).

³⁶ Intel internal measurement. (Feb 2009) Stream-Triad benchmark. Red Hat Enterprise Linux Server 5.3. Intel® Xeon® processor E5472, 3.0 GHz, 2x6MB L2 cache, 1600MHz system bus, 16GB memory (8x2GB FB DDR2-800) vs Intel® Xeon® processor X5570, 2.93 GHz, 8MB L3 cache, 6.4QPI, 24GB memory (6x4GB DDR3-1333).

³⁷ Intel internal measurements of 221W at idle with Supermicro 2xE5450 (3.0GHz 80W) processors, 8x2GB 667MHz FB DIMMs, 1x700W PSU, 1x320GB SATA hard drive vs. 111W at idle with Supermicro software development platform with 2xE5540 (2.53GHz Nehalem 80W) processors, 6x2GB DDR3-1066 RDIMMs, 1x800W PSU, 1x150GB 10k SATA hard drive. Both systems were running Windows 2008 with USB suspend select enabled and maximum power savings mode for PCIe link state power management. Measurements as of Feb 2009.

³⁸ Performance results on VMmark benchmark. Xeon X5470 data based on published results. Xeon X5570 Intel internal measurement. (Feb 2009): HP ProLiant ML370 G5 server platform with Intel Xeon processors X5470 3.33GHz, 2x6MB L2 cache, 1333MHz FSB, 48GB memory, VMware ESX V3.5.0 Update 3 Published at 9.15@ 7 titles vs Intel® Xeon® processor X5570, 2.93 GHz, 8MB L3 cache, 6.4QPI, 72GB memory (18x4GB DDR3-800), VMware ESX Build 140815. Performance measured at 19.51@ 13 titles.

³⁹ Intel internal measurement. (April 2008) Ixia® IxChariot® 6.4 benchmark. VMware® ESX® v3.5U1. Intel® Xeon® processor E5355, 2.66 GHz, 8MB L2 cache, 1333MHz system bus, 8GB memory (8x1GB FB DIMM 667MHz).

Performance tests and ratings are measured using specific computer systems and/or components and reflect the approximate performance of Intel products as measured by those tests. Any difference in system hardware or software design or configuration may affect actual performance. Buyers should consult other sources of information to evaluate the performance of systems or components they are considering purchasing. For more information on performance tests and on the performance of Intel products, visit Intel Performance Benchmark Limitations.

Copyright © 2009 Intel Corporation. All rights reserved. Intel, the Intel logo, Xeon, Core, and Itanium are trademarks of Intel Corporation in the U.S. and other countries.

*Other names and brands may be claimed as the property of others.

Printed in USA

0309/HLW/OCG/PP/2.5K

Please Recycle

321579-001US

